



econo mart



Catálogo
de Productos

www.econo-mart.com



EN
economart

Brindamos soluciones **integrales** para la industria hotelera y foodservice.

Garantizando la **eficiencia, productividad y rentabilidad** en la operación de nuestros clientes, mediante la **asesoría** y suministro de **equipos, utensilios y accesorios** de alta calidad.



CONSULTORÍA | DISEÑO | SUMINISTRO
CAPACITACIÓN | MANTENIMIENTO

Respaldando con **Compromiso, Innovación y Calidad**

Contenido

- 1 SERVICIO DE BANQUETE 4-7
- 2 CUBERTERIA 8-9
- 3 VAJILLA 10-17
- 4 SOBREMESA 18-23
- 5 BEBIDAS 24-29
- 6 BAR 30-32
- 7 BATERIA DE COCINA 33-35
- 8 UTENSILIOS 36-41
- 9 PIZZA 42-43
- 10 TERMOMETROS Y BASCULAS 44-45
- 11 TEXTILES 46-47
- 12 LIMPIEZA 48-54

SERVICIO DE BANQUETE

CHAFER DE ACERO INOXIDABLE

CHAFER

Rectangular fijo de calibre 18/8 y agarradero de bronce full 8 Qt

46050



Madison rectangular cubierta deslizante de 18/8 calibre full de 8 Qt

601



Económico rectangular fijo de calibre 24 y agarradero de plástico full 8 Qt

MCHE20122



Rectangular fijo de calibre 18/8 y agarradero de bronce medio 8 Qt

46035



Madison redondo cubiera deslizante de 18/8 calibre de 6 Qt

602



Económico rectangular replegable de calibre 24 y agarradero de acero full 8 Qt

MCHR20122



Redondo fijo de calibre 18/8 y agarradero de bronce 6 Qt

46030



Inducción redondo con tapa de vidrio de 5.8 lts

46126



Económico rectangular de calibre 24 y agarradero de acero medio 4 Qt

MCHE10122



CALENTADORES

Calentador café de poliuretano 18"W x 25"D x 24 7/8"H

UPC400131



Calentador negro eléctrico para sopas y cremas de aluminio 10 1/2 Qt

ESW-10AL



Calentador de acero inoxidable 7 qt

CM-11



Calentadora Con Tabla P/Trinchar

HL8285GB



ACCESORIOS

Portaquemador para chafers de acero inoxidable

CC-FH



Soporte para chafer de aluminio

C-3F

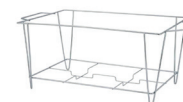

DISPENSADOR DE CEREAL

De pesdeta triple cilíndrico 1 Gal. (Por cilindro)

CRD-3



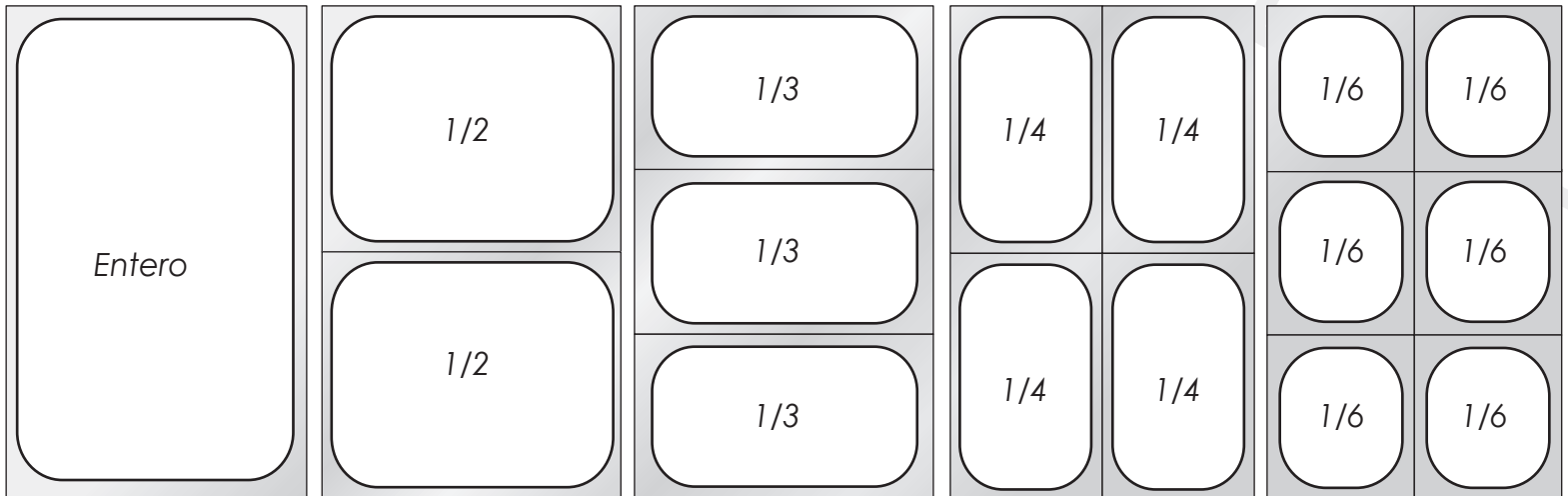

PANAS PARA BAÑOS MARÍA DE ACERO INOXIDABLE

Descripción	Código
24 calibre full 8" de fondo	MCI241120
24 calibre full 6" de fondo	MCI241115
24 calibre full 4" de fondo	MCI241110
24 calibre full 2 1/2" de fondo	MCI241106
24 calibre full perforada 2 1/2" de fondo	MCIP241106
24 calibre medio 6" de fondo	MCI241215
24 calibre medio 4" de fondo	MCI241210
24 calibre medio 2 1/2" de fondo	MCI241206
24 calibre tercio 6" de fondo	MCI241315
24 calibre tercio 4" de fondo	MCI241310
24 calibre tercio 2 1/2" de fondo	MCI241306
24 calibre dos tercios 4" de fondo	MCI242310
24 calibre dos tercios 2 1/2" de fondo	MCI242306
24 calibre un cuarto 6" de fondo	MCI241415
24 calibre un cuarto 4" de fondo	MCI241410
24 calibre un cuarto 2 1/2" de fondo	MCI241406
24 calibre un sexto 6" de fondo	MCI241615
24 calibre un sexto 4" de fondo	MCI241610
24 calibre un noveno 2 1/2" de fondo	MCI241606
24 calibre un sexto 2 1/2" de fondo	MCI241906



TAPAS PARA BAÑOS MARÍA DE ACERO INOXIDABLE

Descripción	Código
24 calibre full lisa	MCT241100
24 calibre full ranurada	MCTA241100
24 calibre medio lisa	MCT241200
24 calibre medio ranurada	MCTA241200
24 calibre dos tercios lisa	MCT242300
24 calibre un cuarto lisa	MCT241400
24 calibre un sexto lisa	MCT241600
24 calibre un sexto ranurada	MCTA241600
24 calibre un noveno lisa	MCT241900



ADAPTADORES

Adaptador para panas de baño maria de acero inoxidable 20" **AB-20N**



Adaptador para panas de baño maria de acero inoxidable 33 cm **MCS243300**



Adaptador para panas de baño maria de acero inoxidable 53 cm **MCS245300**



PANAS FRIAS

Full

Descripción	Código
8" de fondo	133PTRA
6" de fondo	132P
4" de fondo	131PTRA
2 1/2" de fondo	130PTRA



Un Noveno

Descripción	Código
4" de fondo	101P
2 1/2" de fondo	100P



Medio

Descripción	Código
8" de fondo	126P
6" de fondo	125P
4" de fondo	124P
2 1/2" de fondo	123P



Descripción	Código
Tapa lisa para pana fría de full	134PTRA
Tapa lisa para pana fría de medio	128PFCF
Tapa lisa para pana fría de un cuarto	114PTRA



Tercio

Descripción	Código
6" de fondo	118P
4" de fondo	117P
2-1/2" de fondo	116P



Descripción	Código
Tapa con orificio para pana fría de medio	128P
Tapa con orificio para pana fría de un tercio	121PTRA
Tapa con orificio para pana fría de un sexto	108PFCF
Tapa con orificio para pana fría de un noveno	102P-23TRA



Un Cuarto

Descripción	Código
6" de fondo	112P
4" de fondo	111PTRA
2-1/2" de fondo	110P



Descripción	Código
Tapa dentada para pana fría de medio	128PTRA
Tapa dentada para pana fría de un tercio	121P86
Tapa dentada para pana fría de un cuarto	114P-86
Tapa dentada para pana fría de un sexto	108PTRA
Tapa dentada para pana fría de un noveno	102P-23FCF
Tapa dentada para pana fría de un noveno	102P



Un Sexto

Descripción	Código
6" de fondo	106P
4" de fondo	105P
2 1/2" de fondo	104P



Descripción	Código
Tapa con border hermetica para pana fría de un tercio	145PBLA



Descripción	Código
Escudridor para pana fría de un tercio	MCFFP1300
Escudridor para pana fría de un tercio	PLPA7130DS
Escudridor para pana fría de un sexto	PLPA7160DS



ENSALADERAS TRASPARENTES

Descripción	Código
Redonda de 5.5 Qt	7212-07
Redonda de 11 Qt	7215-07
Redonda de 18 Qt	7218-07
Redonda de 33 Qt	7223-07



Redonda de Policarbonato 0.60 Qt	PSB6176
----------------------------------	---------



Redonda de Policarbonato 0.60 Qt	BSB18176
----------------------------------	----------



Rectangular de policarbonato 5 Qt	RSB1014CW135
Rectangular de policarbonato 12 Qt	RSB1419CW135



CUBIERTAS TRASPARENTES

Para exhibir alimentos

Con abertura en un extremo de policarbonato 12"x20"	PSD21EH-07
Con abertura en ambos extremos de policarbonato 12"x20"	PSD21DEH



Con abertura en el centro de policarbonato 12"x20"	PSD21CH
--	---------



Sin abertura de policarbonato 21-1/2"x13-3/4"	C-DP1
---	-------



SET DE EXHIBICIÓN

Set de 3 pedestales redondos de hierro para exhibir alimentos (no incluye platos)

BKRR3



Set de 3 pedestales redondos de hierro para exhibir alimentos (no incluye platos)

RIS3



Set de 4 pedestales cuadrados de hierro para exhibir alimentos (no incluye platos)

BKR4



Set giratorio de 3 platos redondos de melamina y base de hierro para exhibir alimentos

TTRSMEL7



Set giratorio de 3 platos rectangulares de melamina y base de hierro para exhibir alimentos

TTMEL3



Base de hierro para plato individual 7"x9"x9.5"

LWUS899



Set soporte para 8 conos (no incluye conos)

MELFCW535



MELFCW535

Tazón 60oz blanco cerámica 12"

CER7



*Conos se venden por separado

Set de 6 plataformas cuadradas

SLRS7

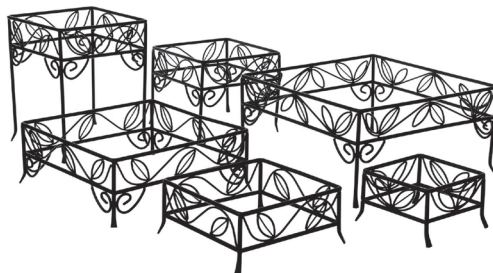

Bar móvil para ensaladas 69"x42 1/2"x62 3/4"

VBR5519



Bandeja rectangular iluminada 54" x 24" x 3.5"

904-12



CUBERTERÍA

ACERO INOXIDABLE

MASCAGNI II

ITEM Descripción

- 1 Cuchara para café de 18/0 calibre 4-1/4"
- 2 Cuchara para té de 18/0 calibre 5-3/4"
- 3 Cuchara para sopa de 18/0 calibre 6-1/2"
- 4 Cuchara para sopa/postre de 18/0 calibre 7"
- 5 Cuchara para ensalada/postre 18/0 calibre 7"
- 6 Tenedor para pescado de 18/0 calibre 7"
- 7 Tenedor de mesa de 18/0 calibre 8"
- 8 Cuchillo para pescado de 18/0 calibre 7-1/2"
- 9 Cuchillo para postre de 18/0 calibre 8"
- 10 Cuchillo de mesa de 18/0 calibre 9 1/2"
- 11 Cuchillo para carnes de 18/0 calibre 9-1/2"
- 12 Espátula para mantequilla 8/0 calibre 6-3/8"

Código

- B023SADF
B023STSF
B023SRBF
B023SDEF
B023FDEF
B023FFSF
B023FDIF
B023KFSF
B023KDEF
B023KPTF
B023KSSF
B023KSBF

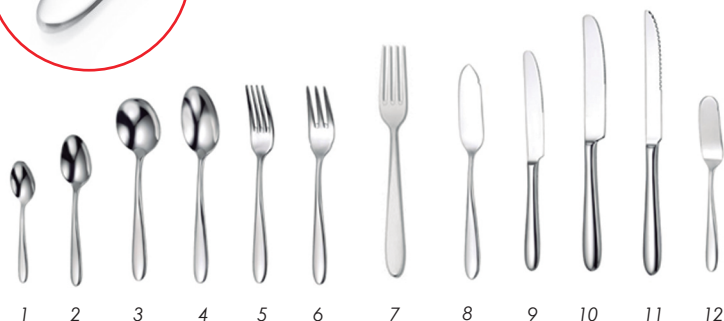

BARCELONA

ITEM Descripción

- 1 Cuchara para café de 18/0 calibre 4-3/8"
- 2 Cuchara para té de 18/0 calibre 6 3/8"
- 3 Cuchara redonda para sopa 18/0 calibre 7"
- 4 Cuchara ovalada para sopa de 18/0 calibre 7 1/4"
- 5 Tenedor para ensalada/postre de 18/0 calibre 7-1/8"
- 6 Tenedor de mesa de 18/0 calibre 7"
- 7 Tenedor de mesa europeo de 18/0 calibre 8 3/8"
- 8 Cuchillo para postre de 18/0 calibre 8 1/8"
- 9 Cuchillo de mesa de 18/0 calibre 8 3/4"
- 10 Espátula para mantequilla de 18/0 calibre 6-5/8"

Código

- B169SADF
B169STSF
B169SRBF
B169SDEF
B169FDEF
B169FDNF
B169FDIF
B169KDAF
B169KPTF
B169KBFF



LAGUNA

ITEM Descripción

- 1 Cuchara para té de 18/0 calibre 6 1/8"
- 2 Cuchara 18/0 calibre 7 3/4"
- 3 Cuchara para sopa de 18/0 calibre 7"
- 4 Tenedor para ensalada/postre de 18/0 calibre 7"
- 5 Tenedor de mesa de 18/0 calibre 7 3/4"
- 6 Cuchillo de mesa de 18/0 calibre 8 5/8"

Código

- B606STSF
B606STBF
B606SDEF
B606FSLF
B606FDNF
B606KPVF



OLD ENGLISH

ITEM Descripción

- 1 Cuchara para té de 18/0 calibre 6 1/4"
- 2 Cuchara para sopa/postre de 18/0 calibre 7"
- 3 Tenedor de mesa de 18/0 calibre 7 3/4"
- 4 Tenedor para ensalada/postre de 18/0 calibre 6 3/4"
- 5 Cuchillo de mesa de 18/0 calibre 8 3/4"

Código

- B817STSF
B817SPLF
B817FDNG
B817FSLF
B817KPVF



MELINDA III

ITEM Descripción

- 1 Cuchara para té de 18/0 calibre 6 1/4"
- 2 Cuchara para sopa/postre de 18/0 calibre 7 1/8"
- 3 Tenedor de mesa de 18/0 calibre 7 1/4"
- 4 Cuchillo de mesa de 18/0 calibre 8 3/4"

Código

- B072STSF
B072SPLF
B072FPLF
B072KPVF



WINDSOR III

ITEM Descripción

- 1 Cuchara para café de 18/0 calibre 4 5/8"
- 2 Cuchara para té de 18/0 calibre 6"
- 3 Cuchara para servir de 18/0 calibre 7 3/4"
- 4 Cuchara para sopa/postre de 18/0 calibre 7"
- 5 Tenedor para ensalada/postre de 18/0 calibre 6 1/4"
- 6 Tenedor para mesa de 18/0 calibre 7"
- 7 Cuchillo para mesa de 18/0 calibre 8"

Código

- B401SADF
B401STSF
B401STBF
B401SPLF
B401FSLF
B401FPLF
B401KGWF



ESPECIALES PARA BUFÉ

ITEM Descripción

- 1 Cuchara solida de bufé de 11 3/4"
- 2 Cuchara con pico para bufé de 2 Oz
- 3 Cuchara ranurada para bufé de 11 3/4"
- 4 Cuchara dentada para bufé de 11 3/4"
- 5 Cuchara ovalada para pasta de bufé de 11 1/2"
- 6 Cucharón profundo de 4 Oz
- 7 Tenedor de dos picos de 12 1/2"
- 8 Tenedor de cuatro picos de 10"
- 9 Espátula para pastel de 11"
- 10 Espátula para pastel en forma triangular de 11 1/2"
- 11 Cuchillo para pastel de acero inoxidable de 8"

Código

- HB-1/PH
HB-10/PH
BW-SL2
BW-NS3
2068
BW-DL
HB-8/PH
BW-CF
BW-PS5
BW-WPS6
BW-DK8



VAJILLAS

PORCELANA Y MELAMINA



PLATOS BLANCOS REDONDOS BORDE DELGADO

ITEM	Descripción	Código
1	Buffalo 7 1/4"	F8000000125
2	Buffalo 8 1/4"	F8000000133
3	Buffalo 9"	F8000000139
4	Buffalo 10"	F8000000147
5	Buffalo 10 3/8"	F8000000150



PLATOS BLANCOS OVALADOS BORDE DELGADO

ITEM	Descripción	Código
1	Buffalo 10"x7 3/4"	F8000000375
2	Buffalo 13 1/2"x10 3/16"	F8000000375



PLATOS BLANCOS BORDE ANCHO

ITEM	Descripción	Código
1	Bowl Buffalo de pasta/ ensalada 10 3/4" 44 Oz	F8010000153
2	Bowl Buffalo blanco de pasta /ensalada 12"	F8010000785



PLATOS BLANCOS REDONDOS BORDE ANCHO

Descripción	Código
Plato Buffalo blanco redondo para pizza 12"	F8010000898



ITEM	Descripción	Código
1	5 1/2"	F8010000149
2	6 1/4"	F8010000117
3	7 1/8"	F8010000124
4	9"	F8010000139
5	9 3/4"	F8010000145
6	11"	F8010000156
7	12"	F8010000163



PLATOS BLANCOS OVALADOS BORDE ANCHO

ITEM	Descripción	Código
1	Buffalo 10"x7 3/4"	F8000000375
2	Buffalo 13 1/2"x10 3/16"	F8000000375



PLATOS BLANCOS CUADRADOS BORDE DELGADO

Descripción	Código	
Buffalo 5 1/2"	F8010000111S	
Buffalo 10 1/2"	F8010000151S	
Buffalo 11 7/8"	F8010000162S	

PLATOS BLANCOS CUADRADOS BORDE ANCHO

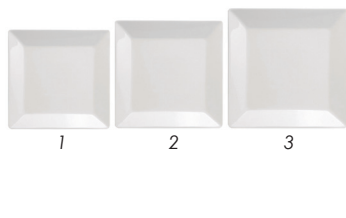
ITEM	Descripción	Código	
1	Buffalo 5"	F8010000115S	
2	Buffalo 8 1/2"	F8010000136S	
3	Buffalo 9 7/8"	F8010000147S	
4	Buffalo 6 1/4"	F8010000117S	
5	Buffalo 7 1/2"	F8010000127S	
6	Buffalo 9"	F8010000139S	
7	Buffalo 10 1/4"	F8010000149S	
8	Buffalo 12"	F8010000163S	

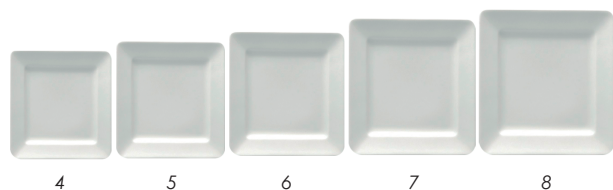

PLATOS BLANCOS RECTANGULARES BORDE ANCHO

Descripción	Código	
Buffalo 11 3/8" x 6 15/16"	F8010000359S	
Buffalo 14 1/2" x 6 3/4"	F8010000373S	
Buffalo 13 1/4" x 9 1/3"	F8010000383S	

Descripción	Código	
Bandeja Buffalo rectangular 16" x 5 7/16"	F8010000415S	

PLATOS BLANCOS RECTANGULARES PARA SUSHI

Descripción	Código	
Buffalo 11" x 5 1/4"	F8010000859	
Buffalo 13" x 6 1/4"	F8010000873	
Buffalo 15" x 7 1/4"	F8010000891	

BOWLS BLANCOS TRIANGULARES

Descripción	Código	
Buffalo 6 1/2" 30 3/4 Oz	F8010000765	
Buffalo 8" 53 1/2 Oz	F8010000767	
Buffalo 9 3/8" 95 Oz	F8010000769	

BOWLS BLANCOS REDONDOS Y OVALADOS

Descripción	Código	
Buffalo para frutas 6" 12 Oz	F8010000720	

Descripción	Código	
Buffalo Nappie 5" 11 Oz	F8000000730	
Buffalo Nappie 5 3/4" 13 1/2 Oz	F8000000731	
Buffalo Nappie 5 1/2" 15 Oz	F8000000761	

Descripción	Código	
Buffalo 6 1/4"	F8010000754	
Buffalo 7 3/4"	F8010000756	
Buffalo 8 3/4"	F8010000758	

BOWLS Y RAMEKINES BLANCOS

Descripción	Código	
Buffalo bouillon 3 7/8" 7 Oz	F8010000700	
Buffalo bouillon 3 1/4" 9 1/2 Oz	F8010000705	

Descripción	Código	
Mini ramekin Buffalo blanco 2 3/8" 1 1/2 Oz	F8010000610M	

ITEM	Descripción	Código	
1	Buffalo cuadrado para salsa 5 3/8" 11 4/5 Oz	F8010000704S	
2	Buffalo cuadrado 5" 15 1/5 Oz	F8010000714S	

ITEM	Descripción	Código	
1	Salsero Buffalo blanco cuadrado 3 1/4" 4 Oz	F8010000953	
2	Salsero Buffalo blanco 2 7/8" 2 Oz	F8010000952	
3	Salsero Buffalo blanco ovalado 4 1/4" x 2 1/8" 2 Oz	F8010000951	
4	Salsero Buffalo blanco con agarradera 4 3/4" 3 Oz	F8010000820	

BOWLS Y RAMEKINES BLANCOS

ITEM	Descripción	Código
1	Ramekin Buffalo blanco 2 3/4" 2 3/4 Oz	F800000613
2	Ramekin Buffalo blanco 3" 3 Oz	F800000614
3	Ramekin Buffalo blanco estriado 1" 1 3/4 Oz	F8010000610
4	Ramekin Buffalo blanco estriado 1 1/2" 2 1/2 Oz	F8010000612



ITEM	Descripción	Código
1	Mini bowl Buffalo blanco para gratinar 4 3/16" 1 Oz	F8010000601M
2	Bowl Buffalo blanco para soufflé 3 5/8" 5 Oz	F8010000600
3	Bowl Buffalo blanco para soufflé 4 5/8" 10 Oz	F8010000603
4	Mini frypan Buffalo blanco 4 3/16" 1 Oz	F8010000660M
5	Cuchara Buffalo blanca china 5"	F8010000794



TAZAS Y ESCUDILLAS BLANCAS

Buffalo para espresso 3 1/2 Oz
F8010000525



Buffalo para café 7 1/2 Oz
F8010000530



Buffalo para café 9 Oz
F8010000560



Taza blanca Jumbo para capuccino 14 Oz
F8010000524



Buffalo para café 7 Oz
F8010000510



Buffalo para café 8 Oz
F8000000521



Buffalo para capuccino 12 Oz
F8010000563



Buffalo para té caliente 4 1/2 Oz
F8010000590



Buffalo para taza de espresso 4 1/4"
F8010000505



Buffalo para taza de café 5 5/8"
F8010000500



Buffalo para taza jumbo de capuccino 6 7/8"
F8010000504



Tetera Buffalo blanca 8" 15 1/4 Oz
F8010000860



Cremera Buffalo con agarradero 4" 4 1/2 Oz
F8010000802



Azucarera Buffalo blanca 3 1/4" x 2 5/8"
F8010000906



**PLATOS CREMA REDONDOS
BORDE DELGADO**

Descripción	Código
7 1/2"	F9000000127
10-1/4"	F9000000149

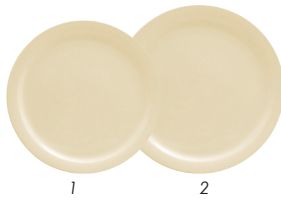

1 2

**PLATOS CREMA REDONDOS
BORDE ANCHO**

ITEM	Descripción	Código
1	Buffalo 7-1/8"	F9010000124
2	Buffalo 10 1/2"	F9010000151
	Buffalo 12"	F9010000163



1 2 3

PLATOS BLANCOS OVALADOS BORDE ANCHO

ITEM	Descripción	Código
1	Buffalo 12"	F9010000367
2	Buffalo 15"	F9010000391



1 2

BOWLS CREMA REDONDOS Y OVALADOS

Para Pasta / Esalada

Buffalo para frutas 7 1/2 Onzas	F9010000711
------------------------------------	-------------



Buffalo nappie 15 Onzas	F9010000733
----------------------------	-------------



Descripción	Código
Buffalo 32 Oz	F9010000756
Buffalo 48 Oz	F9010000758
Buffalo 68 Oz	F9010000759



TAZAS Y ESCUDILLAS CREMAS

Buffalo para café 7 Oz	F9000000510
---------------------------	-------------



Buffalo para café 8 Oz	F9010000520
---------------------------	-------------



Buffalo para café 8 Oz	F9000000560
---------------------------	-------------



Buffalo para taza de café 5 1/2"	F9010000501
-------------------------------------	-------------



Buffalo para taza de café 6 1/8"	F9010000502
-------------------------------------	-------------



PLATOS BLANCOS REDONDOS DE MELAMINA BORDE DELGADO

ITEM	Descripción	Código
1	7-1/4"	NS107W
2	9"	NS109W
3	10-1/4"	NS110W
4	9"	PCD209-02



PLATOS BLANCOS OVALADOS DE MELAMINA BORDE DELGADO

ITEM	Descripción	Código
1	1/2"	NS512W
2	13-1/4"	NS515W
3	15 1/2"	NS516W



TAZONES BLANCOS DE MELAMINA

Tazon de 11oz	
PS5005W	

Tazon de 10 Oz	
CR5804W	

Tazón de 57 Oz	
43739-02	

Tazón de 87 Oz	
NS5095W	

Tazón 30 Oz	
NS5065W	

Tazón 32 Oz	
CR5807W	

Tazón de 24 Oz	
CR5807V	

Tazón blanco de melamina 13 Oz	
SRB13148	

Tazón blanco con agaradero de melamina 12 Oz	
7420-02	

PLATOS BLANCOS OVALADOS DE MELAMINA BORDE ANCHO

ITEM	Descripción	Código
1	7-7/8"	CR007W
2	9 1/4"	CR009W
3	10 1/2"	CR010W
4	11"	CR5811W



PLATOS BLANCO OVALADOS DE MELAMINA BORDE ANCHO

ITEM	Descripción	Código
1	9-1/2"x 7-1/4"	CR209W
2	12"x 9"	CR212W
3	13-1/2" x 10 1/2"	CR213W
4	12" x 8-1/2"	ARR120-02
5	12" x 8-1/2"	43840-02



TAZAS Y ESCUDILLAS DE MELAMINA

Para café 7 Oz	
CR9018W	

Para café 8 Oz	
ML901W	

Para café 8 Oz	
8004-02	

Escudilla de 5 1/2"	
8004-02	

PLATOS CUADRADO DE MELAMINA

ITEM	Descripción	Código
1	Borde ancho 4" X 4"	PS3204W
2	Cuadrado de 8-1/4" x 8 1/4"	PS3208W
3	Cuadrado de 10-1/4" x 10 1/4"	PS3211W
4	Borde redondo de 6-1/4"	43822-02
5	Borde redondo de 8" x 8"	43308-02
6	Borde redondo de 11 1/2" x 11 1/2"	43304-02



PLATOS BLANCOS RECTANGULARES DE MELAMINA

ITEM	Descripción	Código
1	10-1/4" x 4"	29110WT
2	15" x 5-1/4"	29115WT

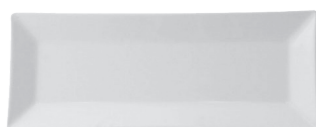

Bandeja rectangular blanca de tres compartimentos de melamina
51316-PAQ



SALSERAS DE MELAMINA

Descripción: Rectangular de 2 Oz
Código: 0864-02



Ramekin cuadrado doble blanco de melamina
0862-02



Palillos chinos plasticos color blanco (paq de 10 pares)
51316-PAQ



PLATOS OVALADOS DE MELAMINA CON ASAS

ITEM	Descripción	Código
1	3" x 4-1/4" 8 Oz	7405-02
2	8-3/4" x 5-3/16" 12 Oz	7400-02



MELAMINA BAMBOO

ITEM	Descripción	Código
1	Plato redondo borde ancho de 10 3/8"	1010BB
2	Plato redondo borde ancho de 14 1/8"	1014BB
3	Bandeja rectangular de 17" x 12 5/8"	0903BB
4	Bote para sushi 16 1/4" x 7 1/8" 54 Oz	8006BB
5	Tazón blanco de 47 oz para fideos dia. 8.5"	5075BB



PLATOS MARFIL DE MELAMINA BORDE ANCHO

ITEM	Descripción	Código
1	9-1/2" x 7-1/4"	CR209V
2	12"x9"	CR212V
3	13-1/2" x 10 1/2"	CR213V
4	4 5/8" 10 Oz	CR5804V



ITEM	Descripción	Código
1	7-1/2"	CR007V
2	9"	CR009V
3	10-1/2"	CR010V



PLATOS AMARILLO REDONDOS DE MELAMINA BORDE ANCHO

ITEM	Descripción	Código
1	6 1/2"	CR006YW
2	7-7/8"	CR007YW
3	9 1/4"	CR009YW
4	10-1/2"	CR010YW



PLATOS AMARILLO OVALADOS DE MELAMINA BORDE ANCHO

ITEM	Descripción	Código
1	9 1/2" x 7 1/4"	CR209YW
2	12" x 9"	CR212YW
3	13 1/2" x 10 1/2"	CR213YW

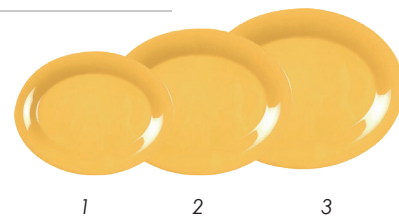

PLATOS PURPURA REDONDOS DE MELAMINA BORDE ANCHO

ITEM	Descripción	Código
1	7-7/8"	CR007BU
2	9-1/4"	CR009BU
3	10-1/2"	CR010BU



PLATOS PURPURA REDONDOS DE MELAMINA BORDE ANCHO

Descripción	Código
13 1/2" x 10 1/2"	CR213BU



Tazon de 32 Oz
CR5807BU

PLATOS ROJO REDONDOS DE MELAMINA BORDE ANCHO

ITEM	Descripción	Código
1	7 1/2"	CR007PR
2	9 1/4"	CR009PR
3	10-1/2"	CR010PR

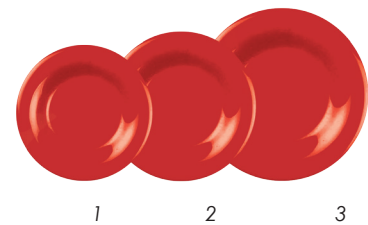

PLATOS ROJO OVALADOS DE MELAMINA BORDE ANCHO

ITEM	Descripción	Código
1	12" x 9"	CR212PR
2	13-1/2" x 10-1/2"	CR213PR



Tazon de 32 Oz
CR5807PR

PLATOS VERDE REDONDOS DE MELAMINA BORDE ANCHO

ITEM	Descripción	Código
1	6-1/2"	CR006GR
2	7-7/8"	CR007GR
3	9 1/4"	CR009GR
4	10-1/2"	CR010GR

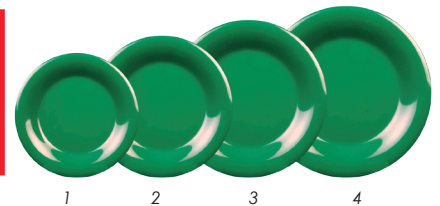

PLATOS VERDE OVALADOS DE MELAMINA BORDE ANCHO

Descripción	Código
12"x9"	CR212GR



RAMEKINES DE MELAMINA



1-1/2 Oz

ITEM	Descripción	Código
1	Blanco liso 1-1/2 Oz	S275-02
2	Blanco hueso liso de 1-1/2 Oz	S275-42
3	Amarillo liso de 1-1/2 Oz	S275-22
4	Naranja liso de 1-1/2 Oz	S275-52
5	Verde liso de 1-1/2 Oz	S275-09
6	Azul cobalto liso de 1-1/2 Oz	S275-60
7	Negro liso de 1-1/2 Oz	S275-03

3 Oz

ITEM	Descripción	Código
1	Blanco liso de 3 Oz	S280-02
2	Hueso liso de 3 Oz	S280-42
3	Rojo liso de 3 Oz	S280-58



2 Oz

ITEM	Descripción	Código
1	Blanco liso de 2 Oz	0852-02
2	Blanco hueso liso de 2 Oz	0852-42
3	Amarillo liso de 2 Oz	0852-22
4	Naranja 2 Oz	0852-52
5	Azul liso de 2 Oz	0852-14
6	Azul cobalto de 2 Oz	0852-60
7	Negro liso de 2 Oz	0852-03
8	Azul cobalto liso de 2 Oz	0852-60
9	Verde liso de 2 Oz	0852-09

4 Oz

ITEM	Descripción	Código
1	Blanco liso de 4 Oz	S285-02
2	Amarillo liso de 4 Oz	S285-22
3	Naranja liso de 4 Oz	S285-52
4	Azul liso de 4 Oz	S285-60
5	Azul cobalto liso de 4 Oz	S285-60
6	Negro liso de 4 Oz	S285-03
7	Blanco liso de 6 Oz	S286-02



ITEM	Descripción	Código
1	Blanco acanalado de 1 1/2 Oz	ML507B
2	Negro acanalado de 2 Oz	S282-03
3	Azul acanalado de 2 Oz	S279-60
4	Cobalto acanalado de 3 Oz	S282-60
5	Azul acanalado 4 Oz	S287-60



SOBREMESA



COPAS

ITEM	Descripción	Código
1	9"	5317
2	4-1/2 Oz	5101
3	5 1/4 Onzas	5314
4	6 Oz	STS-5
5	11-1/2 Oz	5310
6	12 Onzas z	5110
7	18 Onzas 4 1/2"	5118



SERVILLETEROS DE ACERO INOXIDABLE

ITEM	Descripción	Código
1	3 7/8"x 4 3/4"x 5 3/4"	ND-5
2	3 7/8"x 4 3/4"x 7 3/8"	ND-7



PORTA CUBIERTOS

ITEM	Descripción	Código
1	Rack de 4 compartimentos	FCH-4
2	Rack de de 6 compartimentos	FCH-6
3	Vaso perforado para rack	FC-SS
4	Vaso perforado para rack	FC-PL



SALERO/PIMENTERO DE VIDRIO

PIMENTEROS DE MADERA

Descripción	Código
10"	PMW-10
10"	PMW-12



ITEM	Descripción	Código
1	Con tapa cromada 0.5 Oz	G-100
2	Con tapa blanca plástica 1.5 Oz	163MPW
3	Con tapa negra plástica 1.5 Oz	163MPBK
4	Con tapa cromada 2 Oz	SK-PM2
5	Estilo torre con tapa cromada 1 Oz	SK-TWC
6	1.5 Oz con punta de cromo	BPNS115
7	1-1/2" x 6-1/2"	CPM62



CERAMICA

Set De Salero y Pimentero redondos de cerámica 1.5 Oz

160



DISPENSADOR DE QUESO

ITEM	Descripción	Código
1	De SAN con tapa perforada de acero inoxidable 12 Oz	3319-07
2	De plástico con tapa perforada de acero inoxidable 12 Oz	P800



Dispensador de condimentos de 12 Oz.

SK-FPF



AZUCAREROS

ITEM	Descripción	Código
1	De vidrio de 12 Oz	G-102
2	De SAN de 12 Oz	3316-07
3	De policarbonato de 12 Oz	P57S
4	Azucarera de acero inoxidable 10 Oz	T-710



PORTA AZUCAR EN SOBRE

ITEM	Descripción	Código
1	Rectangular blanco de plástico 2.56" de largo	SPH-WH
2	Rectangular negro de plástico 2.56" de largo	SPH-BK
3	Rectangular transparente de plástico 2.56" de largo	SPH-CL
4	Rectangular de acero inoxidable 3-1/2" de largo	58MF



PORTA CONDIMENTOS

Descripción	Código
Porta condimento de 4 compartimentos giratorios incluye recipientes, tapas y cucharas de acero inoxidable	RS-4SS



Descripción	Código
Porta condimento con tapa de plástico transparente 7 Oz	CJ-7AC



Descripción	Código
Rack portacondimento de acero cromado 3 compartimentos redondos	CJ-73H



Descripción	Código
Rack portacondimento de acero cromado 2 compartimentos redondos	CJ-72H



RAMEKIN DE ACERO INOXIDABLE

ITEM	Descripción	Código
1	De 2 1/2 Oz	SCP-25
2	De 1 1/2 Oz	SCP-15



VINAGRERAS Y ACEITERAS

Descripción	Código
Dispensador P/Salsa De Soya 5 Oz	888



Descripción	Código
Transparente base cuadrada de vidrio con vertedor de acero inoxidable 6 Oz	G-104



Descripción	Código
Transparente base cuadrada de vidrio con vertedor de acero inoxidable 8 1/2 Oz	9085



Descripción	Código
Set de vinagrera/aceitera transparente base redonda de vidrio con vertedor cromado 8 onz(Incluye rack cromado)	608N



Descripción	Código
Rack para aceitera y vinagrera con base cuadrada de acero cromado capacidad 2 botellas	OV-HDR



Descripción	Código
Rack redondo para condimentos de acero cromado diámetro 6"	RBNC26



Descripción	Código
Rack redondo para condimentos de metal diámetro 6 3/8"	BKDIA633



Descripción	Código
Rack rectangular para condimentos de acero cromado 12 3/4"x 8 1/4"x10"	5457112R



Descripción	Código
Set De Aceitera/Vinagrera Ponticella 7 Oz C/Rack Vertical	623N



BOTELLAS EXPRIMIBLES

ITEM	Descripción	Código
1	Transparente de polietileno 16 Oz	16SV
2	Roja de plástico 8 Oz	SBY-12
3	Transparente de plástico 8 Oz	SBR-08
4	Amarilla de plástico 12 Oz	SBC-08
5	Roja de plástico 12 Oz	PSB-12R
6	Amarilla de plástico 24 Oz	PSB-24Y



TENAZAS PARA LANGOSTA

Tenaza para langosta de metal

513



Tenaza para langosta de metal

514



Tenaza para langosta de metal

511



MANTEQUILLA

Calentador de mantequilla con base de acero inoxidable

BWPC35



FONDUE

Set de 10 piezas para fondue incluye 6 tenedores cap 6 tazas

509



SALSERAS

Salsera de acero inoxidable 5 Oz

GB-5



Salsera de acero inoxidable 8 Oz

GB-8



Cremero en forma de campana de acero inoxidable 3 Oz

BC-3



CUBREPLATOS

ITEM Descripción

- 10 7/16" a 10 1/2"
- 10 15/16" a 11"
- 11 11/16" a 11 3/4"

Código

COV-113
COV-117
COV-123



ITEM Descripción

- Plato Acero Inoxidable P/Servir
- Tapa P/Recipiente 780D
- Wok De Acero Inoxidable 8"
- Tapa P/Wok De Acero Inoxidable

Código

780D
658C
SLWK008
SLWK008C



ITEM Descripción

- Agarradero para cubre plato
- Para plato ovalada Para plato cuadrado
- 6 compartimentos 14.5x10"

Código

BAKNOB
BAOV972S
BASQ1020
1014502

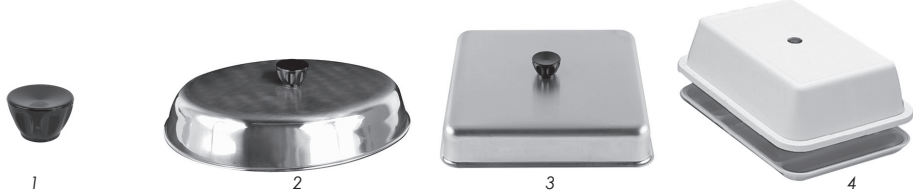

PORTAMENUS

Descripción	Código
2 paneles borde Negro de 9 1/4" x 12"	MCV-2BK
4 paneles borde negro c8-1/2" X 14"	697B
4 paneles borde negro 12" x 9 1/2"	PMCF-9K
8 paneles borde negro 8-1/2" X 14"	502VBK
2 paneles borde rojo 9 1/4" x 12"	MCV-2RD
3 paneles borde rojo 9-1/4" x 12"	MCV-3RD
3 paneles borde verde 9-1/4" x 12"	MCV-3GR



Colores Disponibles



PORTACUENTAS

Porta cuenta 10" x 5.5"

CHK-1K



TARJETEOS Y CLIP

ITEM	Descripción	Código
1	Tarjeteros de mesa acrílico 5"x7"	ACH-57
2	Clip de acero inoxidable 8" de alto	MCH-8
3	Clip de acero inoxidable 12" de alto	MCH-12
4	Clip acrílico sostenedor de trajetas	ACH1



Bandeja para propinas de plástico color negro con letras doradas

TTP-46



Campanilla de acero inoxidable 3.5" de diámetro

CBEL-1



CANASTAS PARA COMIDA RAPIDA

ITEM	Descripción	Código
1	Roja redonda de 8 x 2 3/8"	1075R
2	Verde Plástica 9-1/2"x6"	BB96G
3	Roja Ovalada de 9.25" de largo	BB96R
4	Amarilla valada de 9.25" de largo	BB96Y
5	Redonda terra cotta 10 1/2"	157510TC
6	Redonda rojo 10 1/2"	157510R
7	Negra rectangular de 10 3/4" x 7 3/4 x 1 1/2"	1077BK
8	Roja rectangular de 10 3/4" x 7 3/4 x 1 1/2"	1077R
9	Negra rectangular de 11 3/4" x 8 1/2" x 1 1/2"	1079BK



CANASTAS PARA PAN Y GALLETAS

ITEM	Descripción	Código
1	Redonda de acero cromado 7" de diámetro	BK17410
2	Redonda tejida de 8 1/4" x 2 1/2"	BB-8R
3	Ovalada color negro de metal 9" de largo	BK11709
4	Alargada tejida de 9" x 3 3/4"	BB-94
5	Ovalada tejida de 9 1/2" x 7" x 2 1/2"	BB-97
6	Ovalada color negro de metal 10" de largo	FRUC7
7	Tejida de 13"x5"x3"	1113W

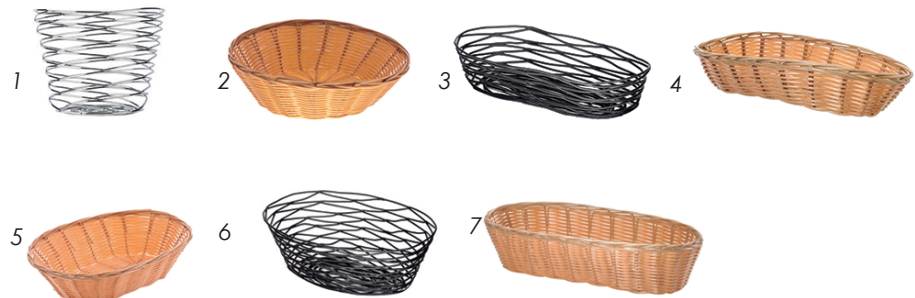

CANASTAS PARA FRITURAS

ITEM	Descripción	Código
1	Redonda de 3-1/2" x 2-7/8"	FRYR375
2	Cuadrada de 4"	FRYS443
3	Angular de para frituras 4 1/2"	FFCS45
4	Conica de hierro para frituras 6" de alto	FCD2
5	Redonda con 2 soportes para ramekin 8" de diámetro	BNBB83
6	Conica de hierro para frituras 9" de alto	FFB59



CANASTAS PARA FRUTAS

ITEM	Descripción	Código
1	Ovalada cromada 9"x6"x3"	FRUC16
2	Redonda con dos niveles para frutas de hierro fundido 20" de alto	TTDB2



PORTA TORTILLAS

ITEM	Descripción	Código
1	Con tapa de plástico azul 7"	0710-14
2	Con tapa de plástico negro 7"	0710-03
3	Con tapa de plástico rojo 7"	0710-29



ENSALADERA DE MADERA

ITEM	Descripción	Código
1	Con tramado de madera 10"	WSB-10
2	Con tramado de madera 12"	WSB-12
3	Con tramado de madera 10"	WRP-10



SERVICIOS DE ALIMENTOS BANDEJAS POLIPROPILENO

ITEM	Descripción	Código
1	Naranja de 10" x 14"	1014FF-166
2	Cafe de 10" x 14"	1014FF-167
3	Rojo 10" x 14"	1014FF-163
4	Verde de 10" x 14"	1014FF-119
5	Amarilla de 12" x 16"	1216FF-108
6	Azul de 12" x 16"	1216FF-186
7	Cafe de 12" x 16"	1216FF-167
8	Naranja de 12" x 16"	1216FF-166
9	Negra de 12" x 16"	1216FF-110
10	Roja de 12" x 16"	1216FF-163
11	Verde de 12" x 16"	1216FF-119
12	Cafe de 14" x 18"	1418FF167
13	Roja de 14" x 18"	1418FF-R



BANDEJA CON COMPARTIMENTOS

ITEM	Descripción	Código
1	6 compartimentos roja de 10" x 14"	P614R-05
2	6 compartimentos verde azulado de 10" x 14"	BCT1014414
3	6 compartimentos de azul 10" x 14"	BCT1014186



BANDEJAS ANTIDESLISANTES

ITEM	Descripción	Código
1	Color café 14"x18"	GT-1418BR
2	Negra con revestimiento de goma 27"x22"	TRH-2722K
3	Negra con revestimiento de goma 16"	TRH-16K
4	Café con revestimiento de goma 16"	TRH-16
5	Negra con revestimiento de goma 14"	TRH-14K
6	Café con revestimiento de goma 14"	TRH-14
7	Café de 11"	GT-1100BR
8	Café de fibra de vidrio 18"x14"	TFG-1814N

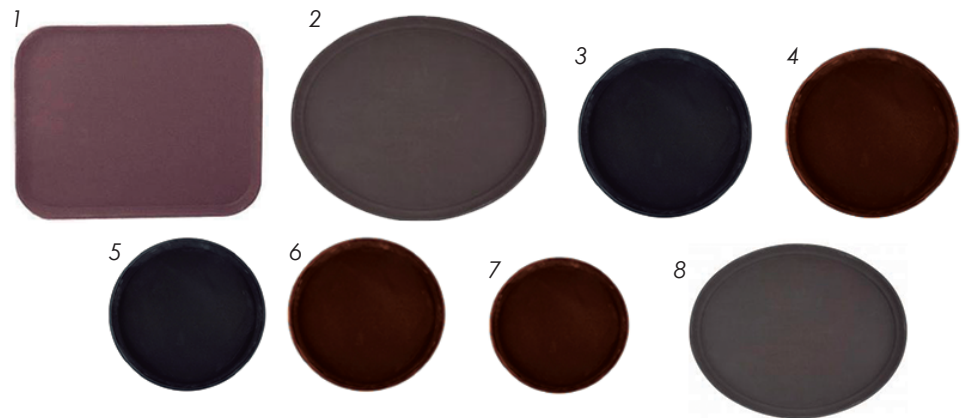

CORCHO

Bandeja redonda de plástico café con superficie de corcho 16"

3016-01



Bandeja ovalada de plástico café con superficie de corcho 24"x19-1/4"

241901



BANDEJA CROMADA

ITEM	Descripción	Código
1	Ovalada Elegance 8" x 12"	STOV128
2	Ovalada Elegance 15" x 10"	STOV1510
3	Redonda Elegance 14"	STRD214
4	Rectangular Elegance 16" x 12"	STR1612



PLATOS BASE

ITEM	Descripción	Código
1	Plateado cromado 12-1/4"	608924
2	Acero inoxidable 15-3/4" x 8-1/2"	OP-16
3	Acero inoxidable 17-3/4" x 11-1/2"	OP-18



BANDEJA DE ACERO INOXIDABLE

ITEM	Descripción	Código
1	Bandeja ovalada de acero inoxidable 26"	SLOP026
2	Bandeja rectangular cromada 16" x 12"	STR1612



BEBIDAS

VASOS GIBRALTAR

ITEM	Descripción	Código
1	7 Onzas 3 1/4" altura	15241
2	7 Onzas 3 3/8" altura	15245
3	8 Onzas 3 5/8" altura	15240
4	7 Onzas 4 1/2" altura	15239
5	9 Onzas 4 3/4" altura	15236
6	10 Onzas 3 7/8" altura	15232
7	10 Onzas 4 3/4" altura	15237
8	12 Onzas 4 5/8" altura	15243
9	12 Onzas 4 7/8" altura	15238
10	12 Onzas 5 7/8" altura	15235
11	14 Onzas 5 1/8" altura	15244
12	16 Onzas 6 3/8" altura	15256
13	22 Onzas 7 3/4" altura	15253



VASOS VIBE

ITEM	Descripción	Código
1	12 Onzas 4 1/8" altura	2311
2	17 Onzas 17 1/2" altura	2312



VASOS ESQUIRE

ITEM	Descripción	Código
1	9 1/4 Onzas 5" altura	225
2	12 1/4 Onzas 5 1/2" altura	259



VASOS PUEBLA

ITEM	Descripción	Código
1	10 Onzas 5 1/2" altura	1789819
2	12 Onzas 5 7/8" altura	1790845



VASOS HEAVY BASE

ITEM	Descripción	Código
1	9 Onzas 4 3/4" altura	125
2	12 1/2 Onzas 5 5/8" altura	159
3	16 Onzas 5 7/8" altura	1639



VASOS ENDEAVOR

ITEM	Descripción	Código
1	9 Onzas 3 7/8" altura	15710
2	14 Onzas 6 5/8" altura	15714



VASO LEXINGTON

Old Fashioned 10 1/4 Onzas 3 1/2" altura	2338
--	------



VASO COSMOPOLITAN

14 Onzas 4 5/8" altura	402
------------------------	-----



COPAS VINA

ITEM	Descripción	Código
1	16 Onzas 8 5/8" altura	7533
2	18 Onzas 8 1/4" altura	7505
3	16 Onzas 6 3/8" altura	7513
4	8 Onzas 9 1/4" altura	7500
5	18 Onzas 8 1/2" altura	7515
6	Martini 12 Onzas 7 3/8" altura	7507



VASOS CERVECEROS

ITEM	Descripción	Código
1	15 Onzas 6 1/4" altura	5298
2	11 Onzas 7" altura	18
3	16 1/2 Onzas 8 5/8" altura	924176
4	23 Onzas 8 7/8" altura	1611
5	14 Onzas 7 3/4" altura	15429
6	14 1/2 Onzas 9 3/8" altura	3823



COPAS PERCEPTION

ITEM	Descripción	Código
1	8 Onzas 7 1/4" altura	3065
2	11 Onzas 7 7/8" altura	3057
3	14 Onzas 8 1/4" altura	3011
4	20 Onzas 8 7/8" altura	3060
5	20 Onzas 8 1/2" altura	3061
6	14 Onzas 6 1/2" altura	3010
7	5 3/4 Onzas 8 1/2" altura	3096



COPAS XXL

ITEM	Descripción	Código
1	24 Onzas 8 5/8" altura	9401RL
2	20 Onzas 8 7/8" altura	9403RL



COPAS EMBASSY

ITEM	Descripción	Código
1	Cordial 1 Onza 4 1/4" altura	3793
2	Cordial 1 1/4 Onzas 4 1/8" altura	3790
3	Cordial 2 Onzas 4 1/4" altura	3792
4	Sherry 3 Onzas 4 7/8" altura	3788
5	Champagne 5 1/2 Onzas 4 1/2" altura	3773
6	Vino 8 3/4 Onzas 6 3/8" altura	3784
7	Vino 8 3/4 Onzas 7" altura	3783
8	Banquet globe 10 1/2 Onzas 6" altura	3721

ITEM	Descripción	Código
9	Champagne 6 Onzas 8 1/8" altura	3795
10	Champagne 6 Onzas 8 3/4" altura	3796
11	Martini 9 1/4 Onzas 6 1/2" altura	3779
12	Postre 2 3/4 Onzas 2 3/4" altura	3801
13	Postre/martini 8 Onzas 3 3/8" altura	3803
14	Poco grande 13 1/4 Onzas 7" altura	3717
15	Brandy 5 1/2 Onzas 4 1/8" altura	3702
16	Brandy 11 1/2 Onzas 5" altura	3705



COPAS TEADROP

ITEM	Descripción	Código
1	6 1/2 Onzas 6 1/4" altura	3966
2	8 1/2 Onzas 7 1/8" altura	3965
3	Goblet 12 Onzas 7 1/4" altura	3911



COPA WHINCHSTER

8 1/2 Onzas 5 7/8" altura

15464



COPA HOFFMAN

Goblet 12 Onzas 6 1/8" altura

5212



COPA HURACAN

14 1/2 Onzas 8 1/4" altura

3616



COPAS STEMLESS

ITEM	Descripción	Código
1	11 3/4 Onzas 4" altura	217
2	17 Onzas 4 1/2" altura	221
3	8 1/2 Onzas 5 3/4" altura	228



COPAS MARGARITA

ITEM	Descripción	Código
1	9 Onzas 6 1/8" altura	8429
2	12 Onzas 6 1/8" altura	3619JS
3	12 Onzas 6" altura	8423
4	12 Onzas 7" altura	30299
5	14 3/4 Onzas 7" altura	8430



Copa 21 Onzas 7 1/4" altura

1722471



Copa super margarita 56 Onzas 10 5/8" altura

1721361

COPA CAPUCCIINO

Copa para capuccino 8 1/2 Onzas 5 7/8" altura

5295



Copa Café Irlandés 8-1/2 Oz

5295



SHOTS

ITEM	Descripción	Código
1	1 Oz 3" altura	1709712
2	1 1/2" Oz 3 5/8" altura	9862324
3	2 Oz 4 1/4" altura	9562269
4	2 1/2 Oz 4 1/8" altura	1650
5	1 1/2 Oz 2 7/8" altura	5127



DECANTERS

ITEM	Descripción	Código
1	6 1/2 Onzas 4 3/4" altura	735
2	10 Onzas 6 1/2" altura	782
3	21 1/2 Onzas 7 3/4" altura	789



PICHELES

ITEM	Descripción	Código
1	8 1/2" Onzas 4 1/2" altura	13129021
2	50 3/4" Onzas 8 1/2" altura	13112221
3	58 Onzas 8 3/4" altura	1783127
4	Pichel de vidrio 1 Litro	1792421



LINEA TOP

ITEM	Descripción	Código
1	Vaso apilable transparente de SAN 12 Oz	5212-07
2	Vaso apilable azul celeste de SAN 12 Oz	5212-54
3	Vaso apilable ambar de SAN 12 Oz	5212-13AB
4	Vaso apilable rojo de SAN 12 Oz	5212-10R
5	Vaso apilable transparente de SAN 16 Oz	5216-07
6	Vaso apilable azul celeste de SAN 16 Oz	5216-54
7	Vaso apilable ambar de SAN 16 Oz	5216-13AB
8	Vaso apilable rojo de SAN 16 Oz	5216-10
9	Vaso apilable azul celeste de SAN 20 Oz	5220-54
10	Vaso apilable ambar de SAN 20 Oz	5220-13
11	Vaso apilable rojo de SAN 20 Oz	5220-10

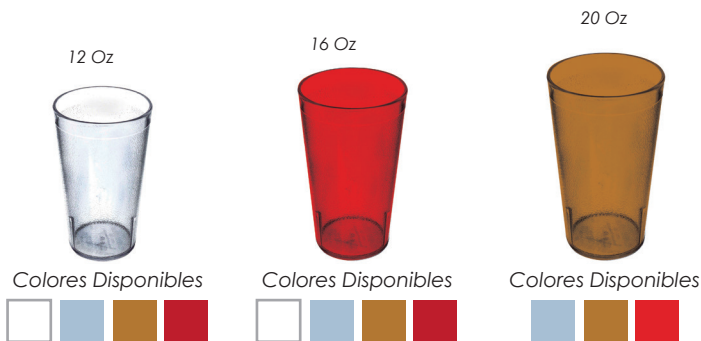

LINEA ECONÓMICA

ITEM	Descripción	Código
1	Vaso transparente de policarbonato 12 Oz	PLTHTB012C
2	Vaso azul celeste de policarbonato de 12 Oz	PLTHTB012B
3	Vaso ambar de policarbonato 12 Oz	PLTHTB012A
4	Vaso rojo de policarbonato 12 Oz	PLTHTB012R
5	Vaso transparente de policarbonato 16 Oz	PLTHTB016C
6	Vaso azul celeste de policarbonato 16 Oz	PLTHTB016B
7	Vaso ambar de policarbonato 16 Oz	PLTHTB016A
8	Vaso rojo de policarbonato 16 Oz	PLTHTB016R
9	Vaso transparente de policarbonato 20 Oz	PLTHTB020C
10	Vaso apilable azul de policarbonato 20 Oz	PLTHTB020B

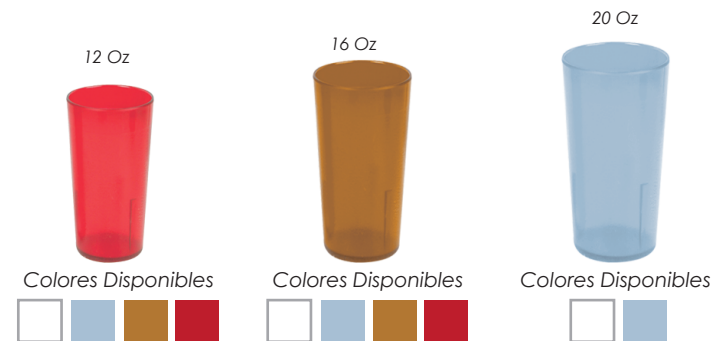

PANELEADOS

ITEM	Descripción	Código
1	Vaso Louis transparente de SAN 8 Oz	5808-07
2	Vaso Bistro transparente de SAN 8 Oz	1108-07
3	Vaso Bistro transparente de SAN 16 Oz	1116-07
4	Vaso Laguna transparente de SAN 14 Oz	LT14152
5	Vaso Laguna transparente de SAN 16 Oz	LT16152



SHOTS, VASOS LISOS Y COPAS

ITEM	Descripción	Código
1	Shot Alibi transparente de SAN 1.5oz	5601-07
2	Shot Alibi transparente de SAN 1.5oz	5602-07
3	Vaso Alibi Old fashion transparente de SAN 12 Oz	5612-07
4	Vaso Liberty cervecero transparente de SAN 15 Oz	43623-07
5	Copa Liberty champagne transparente de SAN 6 Oz	5644-07
6	Copa Liberty martini transparente de SAN 8 Oz	43627-07
7	Copa Liberty margarita transparente de SAN 9.5 Oz	4362407
8	Copa Liberty vino blanco transparente de SAN 10.5 Oz	43621-07
9	Copa Liberty huracan transparente de SAN 15 Oz	43631-07



DECANTER

ITEM	Descripción	Código
1	De policarbonato 1/4 L	WW250CW135
2	De policarbonato 1/2 L	WW500CW135
3	De policarbonato 1 L	WW1500CW
4	De policarbonato 1 1/2 L	WW1000CW135



BEBIDAS CALIENTES

Urna para café de acero inoxidable 3 galones

CU-30GD



BOWL PARA PONCHE



De acero inoxidable 3.5 gal.

SPB-35



De plástico 26 qt

SP18-07

PICHELES INSULADO

ITEM	Descripción	Código
1	Blanco diseño espiral de plástico 20 Oz	F3022/20
2	Negro diseño espiral de plástico 20 Oz	FB3022/20
3	Blanco diseño espiral de plástico 42 Oz	F3022/40
4	Negro diseño espiral de plástico 42 Oz	FB3022/40
5	Blanco diseño espiral de plástico 64 Oz	F3022/60
6	Negro diseño espiral de plástico 64 Oz	FB3022/60



Cubeta para servir bebidas frías 13Qt

UP-13



Hielera transparente de policarbonato de 4 Qt

PLTHBK040C



DISPENSADORES

ITEM Descripción

- 1 Dispensador color negro de plástico 3 Gal.
- 2 Dispensador color amarillo de plástico 3 Gal.
- 3 Dispensador color café de plástico 3 Gal.

Código

- 953-NE
955-AM
954



PICHELES DE POLICARBONATO

ITEM Descripción

- 1 Transparente de SAN 32 Oz
- 2 Bouncer transparente de 32 Oz
- 3 Bouncer transparente de 48 Oz
- 4 Bouncer transparente de 60 Oz
- 5 Transparente de 60 Oz
- 6 Cristalite transparente de 60 Oz
- 7 transparente con tapa de 64 Oz

Código

- WP-32SC
3336
3335
3338
WP-60PC
5587-07
PC64CW-T



PICHELES DE ACERO INOXIDABLE

ITEM	Descripción	Código
1	10 Oz	ESC-10
2	27 Oz	SM-27V
3	33 Oz	SM-33V
4	66 Oz	DWP-66



DISPENSADORES

ITEM	Descripción	Código
1	6 Oz	SYDP-06
2	6 Oz	406-D
3	10 Oz	TTL-10
4	12 Oz	SYDP-12
5	32 Oz	MW32A



GARRAFAS

ITEM	Descripción	Código
1	2 L	CF-2.0
2	1.2 L	CF-1.2
3	4 tazas	WCM08BSSC
4	4 Tazas	WCM04BC
5	64 Oz	40163.0100
6	64 Oz	36029.0000
7	de 8 tazas	5587



TERMOS DE ACERO INOXIDALE

ITEM	Descripción	Código
1	Con base 84 Oz	45882.0000
2	2.5 Lt	32125.0100
3	3 Lt	32130.0100
4	3.8 Lt	36725.0100



PRENSA FRANCESA

ITEM	Descripción	Código
1	10 Oz	78
2	20 Oz	FP-20
3	30 Oz	79



TETERAS

ITEM	Descripción	Código
1	10 Oz	GNS-10
2	12 Oz	SSTP65
3	32 Oz	GNS-32
4	68 Oz	SSCP68



PICHELES DE ACERO INOXIDALE

ITEM	Descripción	Código
1	12 Oz	07000
2	12 Oz	EP-12
3	16 Oz	89
4	20 Oz	07010
5	20 Oz	27202
6	20 Oz	EP-20
7	32 Oz	07011
8	33 Oz	EP-33



ACCESORIOS PARA CAFÉ

ITEM	Descripción	Código
1	Infusor de 4" de diámetro	CI-4
2	Tamper angular con mango plástico 53 mm	21310-53
3	Tamper con mango plástico 58 mm	21330-58
4	Soporte para tampear de cubierto de caucho	23250
5	Vaso de medida de vidrio 3 Oz	25120
6	Knock box de 6.89"x6.3"x5.20"	SCD-5
7	Knock box de madera 7.5" x 7" x 4"	25670
8	Caja para residuos de cafe 6"	27610
9	Caja para residuos de cafe 6"	KB-166



BAR

COCTELERAS

ITEM	Descripción	Código
1	Coctelera con cubierta de plástico 28 Oz	BS-28P
2	Coctelera incluye 3 piezas de 28 Oz	BSH-3P
3	Coctelera incluye 3 piezas de 16 Oz	BSH-3PM



EXPRIMIDOR Y COLADOR

ITEM	Descripción	Código
1	Colador para barra de 4 puntas	BST-4
2	Exprimidor para limón de acero inoxidable	523
3	Exprimidor amarillo para limón de plástico	LS-YE



ABRIDORES Y SACACORCHOS

ITEM	Descripción	Código
1	Sacacorcho manual con campana 5-1/2"	CKS-WB
2	Sacacorcho manual de metal 6 1/2"	CO-712
3	Sacacorcho Deluxe manual y mango de plástico 4 3/4"	CKS-WTR
4	Sacacorchos de alas de acero inoxidable 7"	CKS-6
5	Abridor de cacha de madera	CO-303
6	Abridor chato de acero inoxidable	BO-7F
7	Abridor para sujetar a la pared de acero inoxidable	BO-WM



MORTEROS

ITEM	Descripción	Código
1	marmol 3"	MRGR003
2	marmol 4"	MRGR001
3	marmol 5"	MRGR002
4	Machacador de cabeza de 8"	PBM-8N



Picador para hielo
niquelado y cacha de
madera 9"

IC-9



Cuchara para bar de
acero 11"

BPS-11



Margaritero
Vasos / Copas

GR-3T



MEDIDORES

ITEM	Descripción	Código
1	Medida para trago de 1 y 1/4 Oz	J1-4
2	Medida para trago de 1 y 1/2 Oz	J1-5
3	Medida para trago de 3/4 y 1 1/4 Oz	J1-2
4	Medida para trago de 1 y 2 Oz	J1-6
5	Medida para trago de 1/2 y 1 Oz	J1-1



PALAS ALUMINIO

ITEM	Descripción	Código
1	Pala multiuso de 85 Oz	AS-85
2	Pala multiuso de 38 Oz	AS-38
3	Pala multiuso de 24 Oz	AS-24
4	Pala multiuso de 12 Oz	AS-12
5	Pala multiuso de 5 Oz	AS-5



MONDADIENTE

ITEM	Descripción	Código
1	68mm	PC-F68
2	102mm	PC-F102
3	102mm	PC-PAR
4	3 1/2"	PAP-35JP



BOTELLAS ANTIDERRAME

ITEM	Descripción	Código
1	Botella con boquilla blanca 1 Qt	PPB-1W
2	Botella con boquilla naranja 1 Qt	PPB-1O
3	Botella boquilla verde 1 Qt	PPB-1G



PALAS POLICARBONATO

ITEM	Descripción	Código
1	Pala Bouncer multiuso de 64 Oz	2886
2	Pala Bouncer multiuso de 32 Oz	2884
3	Pala Bouncer multiuso de 6 Oz	2882
4	Pala Bouncer porcionadora de 32 Oz	9G5300
5	Pala Bouncer porcionadora de 24 Oz	9G5200
6	Pala Bouncer porcionadora de 16 Oz	9G5100



DISPENSADORES Y ORGNIZADORES

ITEM	Descripción	Código
1	Dispensador de pajillas 11" de ancho x 6.75" de alto	SD-AC
2	Dispensador de palillos con tapa de 3 agujeros	653TC
3	Dispensador de pajillas 4" de ancho x 11.25" de alto	714CH
4	Organizador de 6 compartimientos 9"x5 1/1"x4 1/4"	BO-6C
5	Bin organizador gris de polietileno 5" x 12"	5412CBP



VERTEDORES

ITEM	Descripción	Código
1	Rojo de plástico 1 Oz	PPA-100
2	De acero inoxidable con corcho de plástico 4 1/2"	POR-MT
3	De acero inoxidable con corcho de plástico 6.8"	PPM-4
4	Con boquilla roja tubo de inmersión 1 Oz	148A
5	Con boquilla roja y tubo de inmersión 1-1/2 Oz	151A
6	Con boquilla roja y tubo de inmersión 2 Oz	153A



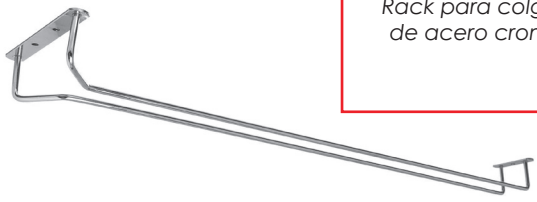

Rack para colgar copas de acero cromado 24"

GHC-24

ALFOMBRAS Y MALLAS

ITEM	Descripción	Código
1	Alfombra para bar de 17 3/4" x 12"	BSM-1218BK
2	Alfombra para bar de 27" x 3 1/4"	BM-27BK
3	Malla para estantes de barra de polietileno antideslizante 0.6m x 12.2m	BL240BK

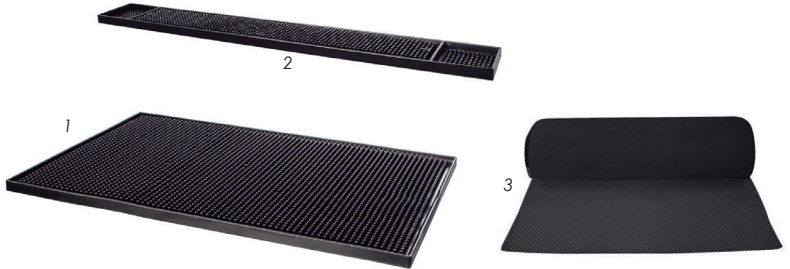

CENICEROS

ITEM	Descripción	Código
1	Rectangular de vidrio para puros	1783682
2	Vidrio cuadrado	952
3	Redondo de plástico negro	AST-4BK
4	Cuadrado de plástico negro con tapa	WPA5BK
5	Redondo de acero inoxidable	SAS-4



Rack para colgar copas de acero cromado 24"

SPR-22S

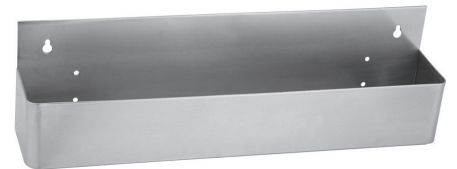

COMANDAS

ITEM	Descripción	Código
1	Acero inoxidable 24"	CHS-24
2	Acero inoxidable 36"	CHS-36
3	Pinchos de metal 3"x6"	CS-36
4	Base giratoria 16"	CW-16

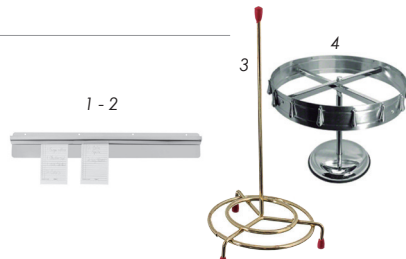

PORTABANDEJAS

ITEM	Descripción	Código
1	31"	TSC-31
2	32"	TSW-32



DISPENSADORES Y ACCESORIOS

ITEM	Descripción	Código
1	Mise en place para barra de dos niveles de plástico 9 Qt	BDS4266
2	Mise en place para barra de un nivel de plástico 4 Qt	BD4005E
3	Dispensador con tapa acrílica para condimentos de 4 compartimentos	CD-4
4	Dispensador con tapa acrílica para condimentos de 6 compartimentos	CD-6
5	Dispensador con bombas para dispensar salsas de 3 compartimentos	38503
6	Kit de bomba estacionaria plástica con 6 tapas 9" de largo dispensa 1 Oz	664K
7	Kit de bomba estacionaria plástica con 6 tapas, 9" de largo dispensa 1 Oz	663TC
8	Bomba estacionaria plástica 9" de largo dispensa 1 Oz	662



CHAMPAGNE

ITEM	Descripción	Código
1	Champañera de 8 7/8" de diámetro	WB-80
2	Pedestal para champañera de 28" de alto Champañera negra de plástico 8" x 6 3/4"	WBS-80 091350BLK24



HIELERAS

ITEM	Descripción	Código
1	Negro 100 libras	ICS100L110
2	Café 100 libras	ICS100L-131
3	Negro 175 libras	ICS175L110



BATERIA DE COCINA

ACERO INOXIDABLE

OLLAS

* Incluye Tapa

ITEM	Descripción	Código
1	16 Qt, 0.8mm espesor	SPS-16
2	20 Qt, 1.0mm espesor	SPS-20
3	32 Qt, 1.0mm espesor	SPS-32
4	40 Qt, 1.0mm espesor	SPS-40
5	60 Qt, 1.2mm espesor	SPS-60
6	100 Qt, 1.2mm espesor	SPS-100



CALDEROS

* Incluye Tapa

ITEM	Descripción	Código
1	15 Qt	SBR-15
2	20 Qt	SBR-20
3	25 Qt	SBR-25



SARTENES

* Incluye Tapa

ITEM	Descripción	Código
1	2 Qt	SSP-2
2	3.5 qt	SSP-3
3	4.5 Qt	SSP-4
4	6 Qt, con asa contrapuesta	SSP-6
5	7 qt, Con asa contrapuesta	SSP-7



SARTENES PARA FREIR

ITEM	Descripción	Código
1	De acero inoxidable 8"	SSFP-8NS
2	De acero inoxidable 11"	SSFP-11NS



De acero inoxidable 12"

77530

De acero carbono con mango de silicona 11"

59949

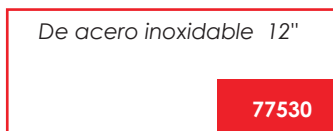

OLLAS

ITEM	Descripción	Código
1	Para caldo de 10 Qt	APT-10
2	Para caldo de 24 Qt	APT-24
3	Para caldo de 32 Qt	APT-32
4	Para caldo de 40 Qt	APT-40
5	Para caldo de 60 Qt	APT-60
6	Para caldo de 80 Qt	APT-80
7	Para caldo de 100 Qt	APT-100
8	Para caldo de 120 Qt	APT-120



Olla para salsas de aluminio
40 Qt

ALP-40



CALDEROS

ITEM	Descripción	Código
1	15 Qt	ABR-15
2	18 Qt	ABR-18
3	24 Qt	ABR-24
4	28 Qt	ABR-28



TAPAS PARA OLLA

ITEM	Descripción	Código
1	Sarten para sofreír de APT-10 / ASAU-3	APTC-10
2	Sarten para sofreír de APT-24 / ASAU-5	APTC-20
3	Sarten para sofreír de APT-32 / APT-40 / ABR-15 / ASAU-7	APTC-40
4	Caldero de aluminio APT-60 / ABR-18	APTC-60
5	Tapa para olla/caldero de aluminio APT-80 / ABR-24	APTC-80
6	Tapa para olla/caldero de aluminio APT-100 / ABR-28	APTC-100
7	Tapa para olla de aluminio reforzado APT-120HD	APTC-120HD
8	Tapa para olla para salsa de aluminio ALP-40	ALPC-40



OLLAS PARA PASTA

ITEM	Descripción	Código
1	20 Qt	APSA-4
2	Inserto para olla de pasta de acero con mango de plástico 1/4 Qt	APSA-INS



CANASTAS VAPORERAS

ITEM	Descripción	Código
1	20 Qt para olla APT-20	ABSK-20
2	32 Qt para olla APT-32	ABSK-32



SARTEN PARA FREIR NO ADHERENTES

ITEM	Descripción	Código
1	Con mango de silicona 11" , 4,5qt	68120
2	Con mango de silicona 11 1/2"	H4015



SARTEN PARA FREIR

ITEM	Descripción	Código
1	Acabado natural de 7"	AFP-07
2	Acabado natural de 8"	AFP-08
3	Acabado natural de 12"	AFP-12
4	Acabado natural de 14"	AFP-14
5	Quantum2 con mango Ergonómico de 7"	AFQ-07
6	Quantum2 con mango ergonómico de 8"	AFQ-08
7	Quantum2 con mango ergonómico de aluminio 12"	AFQ-12
8	Quantum2 con mango ergonómico de aluminio 14"	AFQ-14



MANGOS PARA SARTEN

ITEM	Descripción	Código
1	Modelos AFP-07 / AFP-08 / AFQ-07 / AFQ-08 / ASAU-3	RHDL-S
2	Modelos AFP-10 / AFP-12 / AFQ-10 / AFQ-12 / ASAU-5	RHDL-M
3	Modelos AFP-14 / AFQ-14 / ASAU-7	RHDL-L



SARTEN PARA SALSA

ITEM	Descripción	Código
1	1-1/2 Qt	ASP-1
2	2-3/4 Qt	ASP-2
3	5-1/2 Qt	ASP-5
4	Con manija auxiliar 7 Qt	ASP-7
5	Con manija auxiliar 10 Qt	ASP-10



TAPAS PARA SARTEN

ITEM	Descripción	Código
1	Para ASP-1	ASPC-1
2	Para ASP-2	ASPC-2
3	Para ASP-5	ASPC-5
4	Para ASP-7	ASPC-7
5	Para ASP-10	ASPC-10

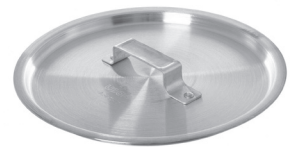

SARTEN PARA SOFREIR

ITEM	Descripción	Código
1	3 Qt	ASAU-3
2	5 Qt	ASAU-5
3	7-1/2 Qt	ASAU-7



Sarten para salsas de aluminio con mango de silicona 8"

77791



SARTENES WOKS ESTILO

ITEM	Descripción	Código
1	16"	34716
2	22"	34722
3	Con un agarradero de madera 14"	IRWC006
4	Con un agarradero de madera 16"	IRWC007
5	28 3/4"	IRWC005



OLLAS DE PRESIÓN

ITEM	Descripción	Código
1	25 Qt	925
2	30 Qt	930
3	41 Qt	941



FREIDORES

ITEM	Descripción	Código
1	Sarten para freír de aluminio 10 Qt	AFPC-7
2	Canasta para freidor modelo AFPC-7	FB-9



Sarten para mini panini con prensa de hierro fundido 6"

653NP



CANASTAS

ITEM	Descripción	Código
1	11"x5-1/2"x4"	FB-115PH
2	12-7/8"x6-1/2"x5-1/8"	FB-126PH
3	13-1/4"x5-3/4"x5-3/4"	FB-135PH
4	17"x8"x5-3/4"	FB-40
5	18 compartimentos	TB-18
6	8 compartimentos	TB-8



UTENSILIOS



CUCHARAS MEDIDORAS

ITEM	Descripción	Código
1	Mango largo 1/4 cucharadita 1-3/4ml	47025
2	Mango largo 1/2 cucharadita 2-1/2ml	47026
3	Mango largo 1 cucharadita 5ml	47027



CUCHARONES DE UNA PIEZA

ITEM	Descripción	Código
1	Mango corto 6" 1 Oz	LOP-10SH
2	Mango corto 6" 2 Oz	LOP-20SH
3	Mango largo 10 1/2" 1/2 Oz	LOP-05
4	Mango largo 10 1/2" 1 Oz	LOP-10
5	Mango largo 12 1/2" 4 Oz	LOP-40
6	Mango largo 13" 6 Oz	LOP-60
7	Mango largo 13 1/2" 8 Oz	LOP-80
8	Mango largo 15" 12 Oz	LOP-120
9	Mango largo 15" 16 Oz	LOP-160
10	Mango largo 15" 24 Oz	LOP-240
11	Mango largo 15" 32 Oz	LOP-320



CUCHARAS

ITEM	Descripción	Código
1	Sólida de 11"	BSLD-11
2	Perforada de 11"	BSPF-11
3	Sólida de 13"	BSLD-13
4	Perforada de 13"	BSPF-13
5	Sólida de 18"	BSLD-18HD
6	Perforada de 18"	BSPF-18HD



CUCHARAS CON AGARRADERO PLASTICO

ITEM	Descripción	Código
1	Sólida de 11"	BBLD-11N
2	Perforada de 11"	BBPF-11N
3	Ranurada de 11"	BBOT-11N
4	Sólida de 13"	BBLD-13N
5	Perforada de 13"	BBPF-13N
6	Ranurada de 13"	BBOT-13N
7	Sólida de 15"	BBLD-15N
8	Perforada de 15"	BBPF-15N
9	Ranurada de 15"	BBOT-15N



UTENSILIOS DE NYLON

ITEM	Descripción	Código
1	Cuchara sólida de 12 3/8"	3580
2	Cucharón sólida para sopa de 12-1/8"	3578
3	Cuchara ranurada de 12 3/8"	3581
4	Cuchara para espaguetis de 11 3/4"	3587JR
5	Espumadera de 14 1/4"	3582
6	Espátula ranurada 13"	3583
7	Espátula Para Pescado	NKU-05
8	Trinchante resistente al calor	NKU-03
9	Majador de Papas	NKU-09



CUCHARAS DE MADERA

ITEM	Descripción	Código
1	12"	WWP-12
2	14"	WWP-14
3	16"	WWP-16
4	18"	WWP-18



DECORADOR DE MELON

ITEM	Descripción	Código
1	Con madera	SLMLB002
2	Con agarradero plastico negro	EGU-3



CUCHARAS PARA HELADOS

ITEM	Descripción	Código
1	Con mango plástico gris 4 Oz	ICD-8
2	Con mango plástico verde 3 1/4 Oz	ICD-12
3	Con mango plástico azul 2 3/4 Oz	ICD-16
4	Con mango plástico amarillo 2 Oz	ICD-20
5	Con mango plástico morado 7/8 Oz	ICD-40
6	De aluminio 1 1/2 Oz	AICD-24
7	De aluminio 2 Oz	AICD-20
8	De aluminio 2 1/2 Oz	AICD-16



PELADORES

ITEM	Descripción	Código
1	6"	6020CA
2	6"	PR-6BC
3	7 1/4"	EGU-5
4	5 1/2"	EGU-8
5	7 1/2"	EGU-10



ITEM	Descripción	Código
1	Con agarradero de plastico negro	E5603
2	Doble cuchilla acero inoxidable	90017



CORTADOR DE VEGETALES

ITEM	Descripción	Código
1	De hierro fundido con cuchilla 1/4"	IRFFC001
2	Cuchilla de repuesto 3/8"	IRFFC002
3	Cuchilla de repuesto 1/4"	IRFFC001B
4	Cuchilla de repuesto 3/8"	IRFFC002B
5	Cuchilla de repuesto macho para IRFFC001	IRFFC001W
6	Cuchilla de repuesto macho para IRFFC002	IRFFC002W



Mandolina de acero inoxidable 17"x6x9"

MS-SS



Cuchara para Papas Fritas

FFB-1R



RAYADORES

ITEM	Descripción	Código
1	2 vías 3.45"	GT-345
2	3 vías 10"	345
3	una sola vía 14" x 5"	354
4	una vía económico 9-1/2"	EGU-6
5	4 vías 4"x4"x9"	GR-449
6	4 vías 3" x 4" x 9"	SG200
7	Estilo tambor	GRTS-1



ABRIDORES

ITEM	Descripción	Código
1	Ajustable a mesa de 7-1/2"	426
2	Ajustable a mesa económico 7-1/2"	EGU-11
3	Ajustable a mesa económico 14"	IRTC014
4	Ajustable a mesa premium 16"	BCO-1
5	Ajustable a mesa Anmaster 16"	BCO-4



BARRA MAGNÉTICA

ITEM	Descripción	Código
1	Para sostener cuchillos 18"	MTH-18P
2	Para sostener cuchillos 24"	MTH-24P



TIJERAS

ITEM	Descripción	Código
1	De plástico negro 4"	9007
2	Para cocina 8"	W656
3	Plástico negro 8 1/2"	EGU-7
4	Para pollo 10"	715
5	Agarradero negro 10"	498-10



CUCHILLOS

ITEM	Descripción	Código
1	Para Carnes de 9 3/4"	B770KSSK
2	Para Carnes de 10 3/4"	B620KSSF
3	Juego para pelar (3piezas) 3-1/4"	SC0500-3
4	Para Filetear y deshuesar azul 6"	B5607-6
5	Para Filetear y deshuesar rojo 6"	R5607-6
6	Para Filetear y deshuesar amarillo 6"	Y5607-6
7	Para Filetear y deshuesar blanco 8"	W5613-8
8	Cebollero blanco 8"	W5610-8
9	Cebollero azul 8"	B5610-8
10	Cebollero rojo 8"	R5610-8
11	Cebollero amarillo 8"	Y5610-8
12	Cebollero verde 8"	G5610-8
13	Para cocinero blanco 10"	W5610-10
14	Para cocinero azul 10"	B5610-10
15	Para cocinero rojo 10"	R5610-10
16	Para cocinero amarillo 10"	Y5610-10
17	Para cocinero verde 10"	G5610-10
18	Para cocinero blanco 12"	W5610-12
19	Aserrada curva 9"	W5620-9E
20	Punta redonda 12"	W5627-12E
21	Para jamón sin sierra 10"	W5627-10GE
22	Para jamón sin sierra 12"	W5627-12GE
23	Para despellejar curvo 8"	5602-8
24	Para despellejar curvo 10"	5602-10
25	Estilo cimentera punta curva 10"	5617-10
26	Estilo cimentera punta curva 12"	W5617-12
27	Carnicero 10"	W5625-10
28	Carnicero 10"	W5520-10
29	Carnicero 14"	W5520-14
30	Hacha 6"	W5550-6
31	Hacha 8-1/2"	47311
32	Hacha 8"	47315

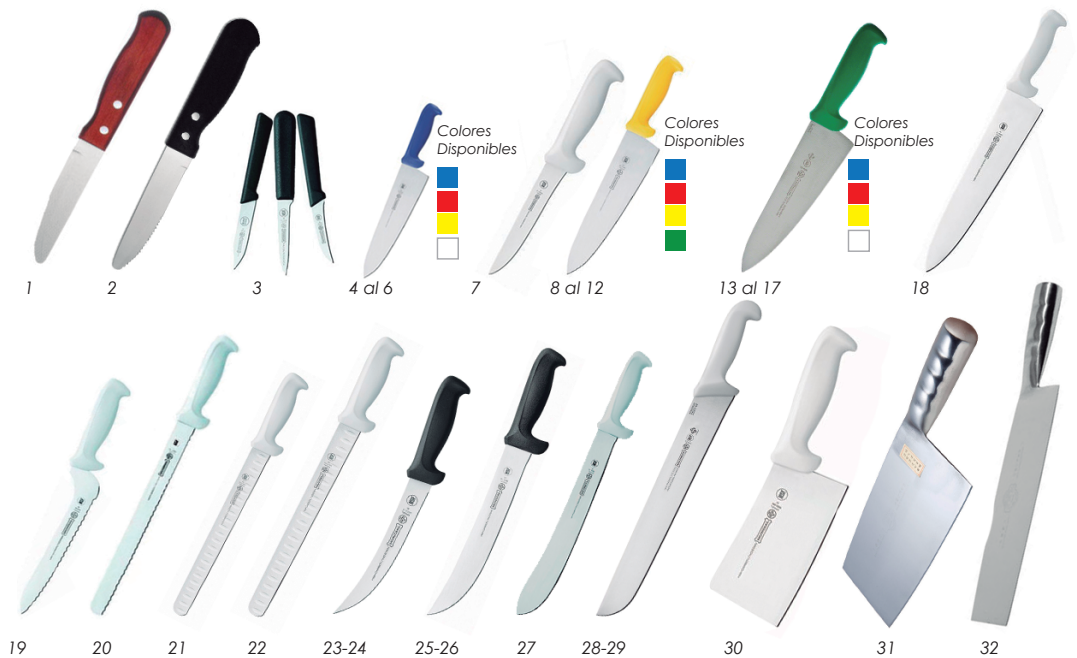

AFILADORES DE CUCHILLO

ITEM	Descripción	Código
1	Premium negro 14"	3306-14
2	Blanco 14"	W3303-14
3	Negro económico 14"	G-1T
4	policarbonato hoja en acero	90015GDCM01
5	Piedra 12" x 2 1/2" x 1 1/2"	G-2512
6	Mango de poliacetal 7" HD	KS75



Rack porta cuchillos 10 compartimentos
12"x12-3/4"x2-1/2"

KR-1212



ESPÁTULAS

ITEM	Descripción	Código
1	Mini de 4"x2 1/2"	W5680
2	Para hamburguesa de 4"x3"	W5686
3	Para mantequilla 3.5"	W5688-3 1/2
4	Para hamburguesa de 4"x3-3/4"	TN46
5	Para hamburguesa de 6-1/2"x3"	WTHD-6PH
6	Perforada de 10"x3"	TN409
7	Sólida de 10"x10"x3"	WTSD-10PH
8	Sólida de 10"x3"x20"	WGT-20
9	4"	5692-4
10	Para pescado de 6-1/2"	FST-6



COLADORES

ITEM	Descripción	Código
1	Malla gruesa de 8"	CC-8C
2	Malla fino de 8"	CC-8F
3	Malla gruesa de 10"	CC-10C
4	Malla fino de 10"	CC-10F
5	Malla gruesa de 12"	CC-12C
6	Malla fino de 12"	CC-12F
7	Malla extrafina de 10"	CCB-10R
8	Malla fina de 6-1/4"	SSF-6/SS
9	Malla fina de 8"	SSF-8/SS
10	Malla fina de 10"	SSF-10/SS
11	Doble malla fina de 8"	SDF-8/SS
12	Doble malla fina de 10"	SDF-10/SS
13	Doble malla mediana de 10"	SDM-10/SS
14	Doble malla reforzada asa plana de 9"	SHD-9/SS
15	Doble malla reforzada asa redonda de 12"	SHD-12/SS
16	Doble malla reforzada asa redonda de 14"	SHD-14/SS
17	8 Qt	COD-8
18	14 Qt	COD-14
19	11 Qt	ACO-11
20	16 Qt	ACO-16



TRINCHANTES

ITEM	Descripción	Código
1	Mango de madera 6-1/2"	KPF-612
2	Mango de madera 21"	KPF-210



MAJADORES

ITEM	Descripción	Código
1	De acero inoxidable 10.75" Niquelado	1240NP
2	Mango de madera de acero 18"	PMRD-18
3	Niquelado mango de madera de acero 24"	PMRD-24
4	Con mango antifatiga de acero 24"	MMRD-24
5	De acero inoxidable 9"	PR-9



ESPUMERAS

ITEM	Descripción	Código
1	Malla de alambre de 7"	601527
2	Malla de alambre de 8"	601528
3	Malla de alambre de 5"	SKM-5WG
4	Malla de alambre de 7"	SKM-7WG
5	Malla de alambre de 8"	SKM-8WG
6	Malla de alambre de 9"	SKM-9WG
7	Malla de alambre de 12"	SKM-12WG
8	Malla de alambre de M6"	SMS-6F

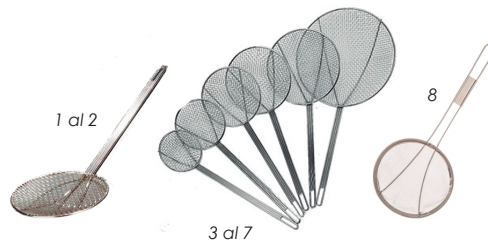

MEZCLADORES

ITEM	Descripción	Código
1	36"	MPS-36
2	48"	MPS-48
3	60"	MPS-60

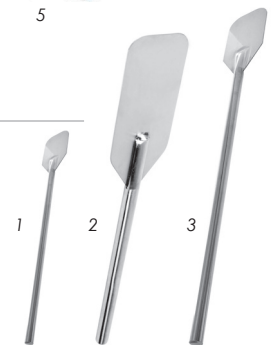

TAZONES ECONÓMICOS

ITEM	Descripción	Código	ITEM	Descripción	Código
1	3/4 Qt	MB-75	5	8 Qt	MB-800
2	1.5 Qt	MB-150	6	13 Qt	MB-1300
3	4 Qt	MB-400	7	16 Qt	MB-1600
4	5 Qt	MB-500	8	20 Qt	MB-2000



Molino de carne
mecánico 150

150



TENDERIZADOR

ITEM Descripción

- 1 Para carne de aluminio
- 2 Para carne de aluminio
- 3 Profesional de acero inoxidable

Código
AMT-10
MT-AL
90009



JERINGA

Jeringa Inyectora

40100CM



CENTRIFUGADOR

ITEM Descripción

- 1 Para ensaladas 2-1/2 Gal
- 2 Para ensaladas 5 Gal

Código
90012
90005



EMBUDOS

ITEM Descripción

- 1 De acero inoxidable 5-3/4"
- 2 Blanco plástico 5 1/4"
- 3 Embudo blanco de plástico 6-1/8"

Código
FSUV-6S
FPW-5
FPW-6



PINCHOS PARA CARNE

ITEM Descripción

- 1 Ovalos de acero inoxidable 10"
- 2 Ovalos de acero inoxidable 12"
- 3 De bambú 8" 100 Und
- 4 De bambú 10" 100 Und
- 5 De bambú 12" 100 Und

Código
SKO-10
SKO-12
SKWB-8
SKWB-10
SKWB-12



TABLAS PARA CORTAR

ITEM Descripción

- 1 Con agarradero verde 12" x 18"
- 2 Con agarradero rojo 12" x 18"
- 3 Con agarradero blanca 12" x 18"
- 4 Con agarradero azul 15" x 20"
- 5 Con agarradero café 15" x 20"
- 6 Con agarradero verde 15" x 20"
- 7 Con agarradero rojo 15" x 20"
- 8 Con agarradero blanco 15" x 20"
- 9 Con agarradero amarilla 15" x 20"

Código
CBG121812GN
CBG121812RD
CBG121812WH
CBG152012BL
CBG152012BR
CBG152012GN
CBG152012RD
CBG152012WH
CBG152012YL



ITEM Descripción

- 1 Blanca 12"x18"x1/2"
- 2 Café 12"x18"x1/2"
- 3 Azul 12"x18"x1/2"
- 4 Roja 12"x18"x1/2"
- 5 Amarilla 12"x18"x1/2"
- 6 Verde 12"x18"x1/2"
- 7 Blanca 15"x20"x1/2"
- 8 Café 15"x20"x1/2"
- 9 Azul 15"x20"x1/2"
- 10 Roja 15"x20"x1/2"
- 11 Amarilla 15"x20"x1/2"
- 12 Verde 15"x20"x1/2"
- 13 Blanca 18"x24"x1/2"
- 14 Café 18"x24"x1/2"

Código
CBWT-1218
CBBN-1218
CBBU-1218
CBRD-1218
CBYL-1218
CBGR-1218WO
CBWT-1520
CBBN-1520
CBBU-1520
CBRD-1520
CBYL-1520
CBGR-1520WO
CBWT-1824
CBBN-1824

ITEM Descripción

- 15 Azul 18"x24"x1/2"
- 16 Roja 18"x24"x1/2"
- 17 Amarilla 18"x24"x1/2"
- 18 Verde 18"x24"x1/2"
- 19 Soporte para tablas de cortar 6 compartimento

Código
CBBU-1824
CBRD-1824
CBYL-1824
CBGR-1824WO
CBRK-6N

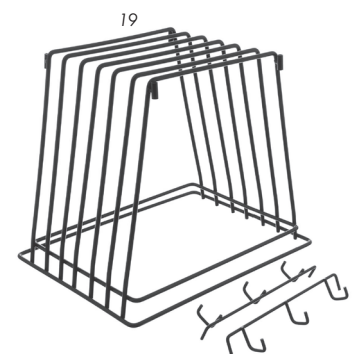

ESPECIALES PARA BUFÉ

ITEM	Descripción	Código
1	Pinza Regency para hielo/alimentos de bufé de acero inoxidable 8 1/2"	RE-120
2	Pinza para azúcar/hielo de bufé de acero inoxidable de 4"	IT400
3	Pinza para azúcar/hielo de bufé de acero inoxidable 6 1/2"	IT700
4	Pinza dentada de bufé de acero inoxidable de 6 1/2"	4405
5	Pinza festoneada de bufé de acero Inoxidable de 10-1/2"	607683
6	Pinza punta redonda para BBQ de bufé de acero inoxidable 9-1/2"	SLTTBN024
7	Pinza para pasta de bufé de acero inoxidable de 6"	SPT-6
8	Pinzas en forma de tijera para ensaladas de bufé de acero inoxidable 8 1/4"	SST-09
9	Pinza dentada para pan de bufé de acero inoxidable de 11 1/2"	SLBT115
10	Pinza lisa rectangular para repostería de bufé de acero inoxidable de 9-1/2"	607695
11	Pinza lisa para repostería de bufé de acero inoxidable de 8"	BU-STG
12	Pinza lisa rectangular para repostería de bufé de acero inoxidable de 9"	PTT-09



MULTIUSO CON MANGO PLÁSTICO

ITEM	Descripción	Código
1	Pinza festoneada con mango de plástico negro 9"	TOPP-9
2	Pinza festoneada con mango de plástico azul de 9"	TOPP-9BL
3	Pinza festoneada con mango de plástico verde de 9"	TOPP-9GR
4	Pinzas festoneada con mango plástico rojo de 9"	TOPP-9RE
5	Pinza festoneada con mango plástico amarillo de 9"	TOPP-9YE
6	Pinza festoneada con mango plástico rojo de 12"	TOPP-12RE
7	Pinza festoneada con mango plástico verde de 12"	UT-12HP-G
8	Pinza festoneada con mango plástico negro de 12"	TOPP-12
9	Pinza festoneada con mango plástico azul 12"	TOPP-12BL
10	Pinza festoneada con mango plástico negra de 16"	TOPP-16
11	Pinza festoneada con mango plástico verde de 16"	TOPP-16GR
12	Pinza festoneada con mango plástico amarillo 16"	TOPP-16YE



MULTIUSO CON PUNTAS Y AGARRADEROS DE SILICON

ITEM	Descripción	Código
1	Pinza festoneada con puntas y agarradero de silicon de 9"	UTS-9K
2	Pinza festoneada con puntas y agarradero de silicon de 12"	UTS-12K



MULTIUSO DE ALTA RESISTENCIA

ITEM	Descripción	Código
1	Pinza festoneada de alta resistencia 9"	ST-9HD/CS
2	Pinza festoneada de alta resistencia 12"	ST-12HD/CS
3	Pinza festoneada de alta resistencia 16"	ST-16HD/CS



MULTIUSO DE PLÁSTICO ALTA RESISTENCIA

ITEM	Descripción	Código
1	Pinza para ensalada de 9"	4609-03
2	Pinza para ensalada de 9"	4609-08
3	Pinza festoneada multiuso de 9"	4709-03



MULTIUSO ECONÓMICAS

ITEM	Descripción	Código
1	Pinzas festoneada de 9"	UT-9
2	Pinza multiuso de 6"	PT-6WO
3	Pinza multiuso 12"	PT-12
4	Pinza de cocina pequeña 5" (Pac/2 uni.)	TZ-05



MULTIUSO DE PLÁSTICO ECONÓMICAS

ITEM	Descripción	Código
1	Pinza festoneada de policarbonato de 9"	PCT-9BK
2	Pinza festoneada de policarbonato de 9"	PCT-9BG
3	Pinza festoneada de policarbonato de 9"	PCT-9WH
4	Pinza festoneada de policarbonato de 9"	PCT-9CL



PIZZA

SARTENES BORDE DELGADO

ITEM	Descripción	Código
1	Borde delgado de aluminio 8"	APZC-8
2	Borde delgado de aluminio 10"	APZC-10
3	Borde delgado de aluminio 12"	APZC-12
4	Borde delgado de aluminio 14"	APZC-14
5	Borde delgado de aluminio 16"	APZC-16
6	Borde delgado de aluminio 18"	APZC-18
7	Borde delgado de aluminio 20"	APZC-20



SARTENES BORDE ANCHO

ITEM	Descripción	Código
1	Para pizza borde ancho de aluminio 8"	APZT-8
2	Para pizza borde ancho de aluminio 10"	APZT-10
3	Para pizza borde ancho de aluminio 12"	APZT-12
4	Para pizza borde ancho de aluminio 14"	APZT-14
5	Para pizza borde ancho de aluminio 16"	APZT-16
6	Para pizza borde ancho de aluminio 18"	APZT-18
7	Para pizza borde ancho de aluminio 20"	APZT-20



REDECILLA

ITEM	Descripción	Código
1	Malla de aluminio 12"	18712
2	Malla de aluminio 14"	18714
3	Malla de aluminio 16"	18716
4	Malla de aluminio 18"	18718
5	Malla de aluminio económica 8"	PS-08
6	Malla de aluminio económica 10"	PS-10
7	Malla de aluminio económica 12"	PS-12
8	Malla de aluminio económica 14"	PS-14
9	Malla de aluminio económica 16"	PS-16
10	Malla de aluminio económica 18"	PS-18
11	Malla de aluminio económica 20"	PS-20



PALA PARA PIZZA

ITEM	Descripción	Código
1	De aluminio con mango de madera 36"	APP-36
3	De aluminio con mango de madera 52"	APP-52



Reventador de burbujas para pizza de aluminio con mango de madera 23"

BP23



CORTADOR

ITEM	Descripción	Código
1	Rueda de acero inoxidable 2-1/2"	PC-2
2	Rueda de acero inoxidable 4"	PC-4
3	Rueda de acero inoxidable 6"	1323

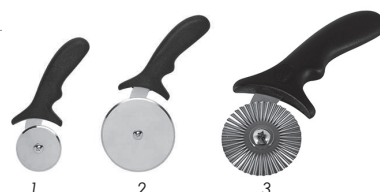

RODILLOS

ITEM	Descripción	Código
1	Con puntas de acero inoxidable y mango de aluminio 5"	RD-5
2	Con puntas de plástico y mango de acero 8"	RD-8

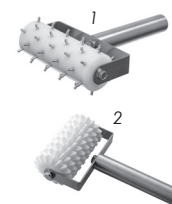

CHAVETAS

ITEM	Descripción	Código
1	Mango de madera 6"	WDS-36
2	Mango de plástico 6"	DSC-2
3	Con relieve Mango de madera 7"	WSER-7

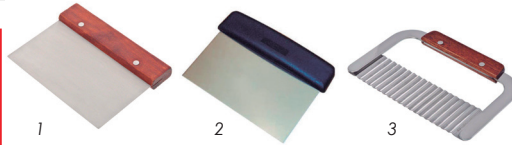

DISPENSADORES

ITEM	Descripción	Código
1	Con tapa perforada de acero inoxidable 6 Oz	SK-RPF
2	De Condimentos C/3 Tapas	PDG-10
3	Con agarradero de acero inoxidable 10 Oz	DRG-10
4	Sin agarradera de acero inoxidable 10 Oz	DRG-10H
5	Sin agarradera de acero inoxidable 22 Oz	DRG-22H
6	Dispensador de condimento de 6 oz.	SK-ROT
7	6oz de plástico con tapa de color blanco	P260WH
8	6oz y tapa de color rojo	P260SLRE



Soporte para sarten de pizza de acero cromado 8"x8"x7"

APZT-789



CAJA Y PATA PARA MASA

ITEM	Descripción	Código
1	46"x66"x7.6cm	DB18263P148
2	Tapa para DB18263P148	DBC1826P148



Rack para Soporte para sarten de pizza 15 compartimento de acero cromado

APZT-1015



DIVISORAS DE MASA

ITEM	Descripción	Código
1	de 5 ruedas de acero inoxidable	ADD-5
2	De 6 ruedas de acero inoxidable	ADD-6

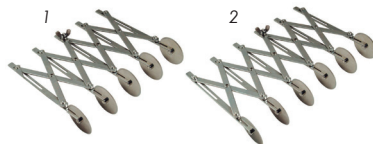

BOLSO DELIVERY

ITEM	Descripción	Código
1	Para pizzas dos compartimentos material insulado 18"	PIB-18
2	Para pizzas dos compartimento material insulado 20"	PIB-20



DIVISORAS DE MASA

ITEM	Descripción	Código
1	Rodo de aluminio 13"	RPA-3513
2	Rodo de aluminio 15"	RPA-3515
3	Rodo de aluminio 18"	RPA-3518
4	Rodo de madera 13"	RPW-3213
5	Rodo de madera 15"	RPW-3215
6	Rodo de madera 18"	RPW-3218

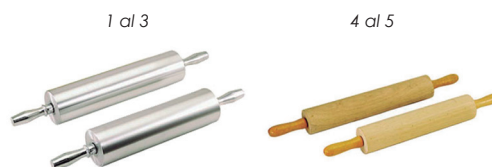

Cepillo para horno de pizza 10"cepillo, 40"mango

90041



TERMÓMETROS Y BÁSCULAS

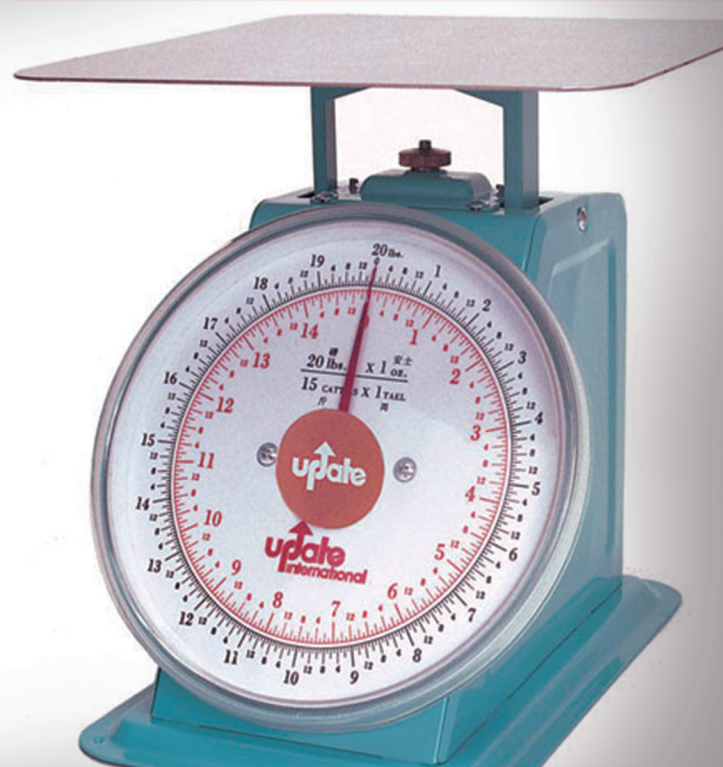

TERMÓMETRO INFRARROJO

Termómetro Infrarrojo -67f a 482c / -55c a 250c

TMP500



TERMÓMETRO DIGITAL

ITEM Descripción

- 1 Digital de bolsillo -58° a 302°F
- 2 Digital de bolsillo -40° a 450°F
- 3 Termómetro digital de -40° a 150°C

Código

THP302L
THDP-450
THDP-302



TERMÓMETRO PARA LÍQUIDOS

Largo altamente resistente

ITEM Descripción

- 1 Análogo Recalibrable 50 a 220°F 5"
- 2 Análogo Recalibrable -30 a 220°F 5-1/2"
- 3 Análogo Recalibrable -30 a 220°F 8"

Código

11160
THFR-17
THFR-17L



TERMÓMETRO ANÁLOGO

ITEM Descripción

- 1 De bolsillo recalibrable -40 a 180°F
- 2 De bolsillo recalibrable 0 a 220°F
- 3 De bolsillo recalibrable 50 a 550°F
- 4 Termómetro De Bolsillo 10° a 287°C

Código

THP-180
THP-220
THP-550
THP550DS



TERMÓMETRO PARA CARAMELO/FREÍR

ITEM Descripción

- 1 Análogo mercurio / Freír 100 a 400°F
- 2 Análogo mercurio Freír 100 a 400°F
- 3 Para dulces/freír 30° a 220°C

Código

THCF-20D
THCF-120L
THC400DS

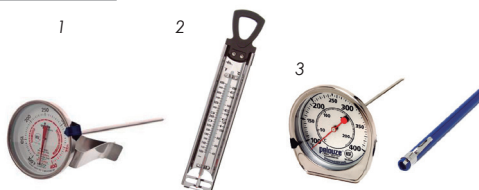

TERMÓMETRO PARA PARRILLA

Termómetro Para Grill / Parrilla 150° F a 700°F.

THGT-20

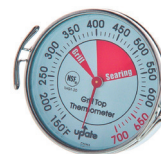

TERMÓMETRO PARA HORNO

ITEM Descripción

- 1 60 a 590°F altamente resistente
- 2 Para horno 50 a 500°F
- 3 Dial 2" 10° a 260°C

Código

THO550
THOV-30
THOV-20



TERMÓMETRO PARA REFRIGERACIÓN

ITEM Descripción

- 1 -20° a 80°F/-30° a 30°C
- 2 -20° a 70°F/-30° a 20°C
- 3 Líquido 20°-80°F.

Código

R80DC
THRE-30
THRE-50L



TEMPORIZADOR

ITEM Descripción

- 1 Digital y análogo 19 horas Horas/ minutos.
- 2 Digital y análogo 60 minutos alarma campana
- 3 Temporizador de 60 Minutos
- 4 Cronómetro Digital 24Hrs con posterior magnético

Código

**TIMD-HM
MT60F
TIM-60LR
FGR442188**



CALIBRADOR

Calibrador de termómetro de 4"

11001



BALANZAS DIGITALES PROPORCIONADORA

ITEM Descripción

- 1 2 lb utiliza pilas AAA (no incluidas)
- 2 12 lb utiliza pilas AAA (no incluidas)
- 3 Escala digital porcionadora de 6lb resina
- 4 Balanza digital cap.20lbs de acero inoxidable

Código

**1812588
1812595
1812593
DPS-20**



BALANZAS ANÁLOGAS

ITEM Descripción

- 1 Plataforma plana 1 lb
- 2 Plataforma plana 2 lb
- 3 Plataforma plana 5 lb
- 4 Plataforma plana 10 lb
- 5 Plataforma plana 20 lb
- 6 Plataforma plana 10 lb

Código

**UP-71
UP-72
UP-75
UP-810
UP-820
UP-710T**

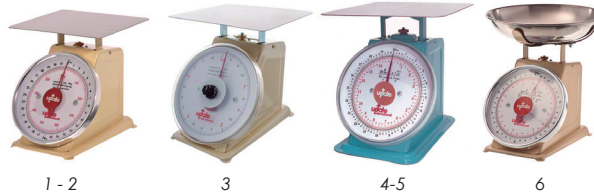

Balanza análoga escala para panadería tazón de acero inoxidable 16 lbs

BD16SC



TEXTILES

GABACHAS PARA CHEF

Caballeros

ITEM Descripción

- 1 Blanco talla XL, botones blanco y ribete de cuello negro
- 2 Blanco talla L, botones blanco y ribete de cuello negro
- 3 Blanco talla M, botones blanco y ribete de cuello negro
- 4 Blanco talla S, botones blanco y ribete de cuello negro
- 5 Blanco talla XL, botones negro y ribete negro en borde
- 6 Blanco talla L, botones negro y ribete negro en borde,
- 7 Color blanco talla XL
- 8 Color blanco talla L
- 9 Color blanco talla M
- 10 Color blanco talla S

Código

- J008-XL
J008-L
J008-M
J008-S
J044-XL
J044-L
J100-XL
J100-L
J100-M
J100-S



1 al 4



5-6



7 al 10

Damas

ITEM Descripción

- 1 Para dama Color blanco talla L, ribete del cuello negro
- 2 Para dama Color blanco talla M, ribete del cuello negro
- 3 Para dama Blanco talla S ribete del cuello negro

Código

- LJ008-L
LJ008-M
LJ008-S



1 al 3

GORROS PARA CHEF

ITEM Descripción

- 1 De polialgodón, negro
- 2 Gorro p/chef blanco
- 3 De papel de 9" desechable (paquete 12 und) blanco

Código

- H008-R
RCH926
PPR HAT 9



1



2



3

PANTALON PARA CHEF

Caballeros

ITEM Descripción

- 1 Color negro talla XL
- 2 Color negro talla L
- 3 Color negro talla M
- 4 Color gris talla XL
- 5 Color gris talla L
- 6 Color gris talla M

Código

- P024BK-XL
P024BK-L
P024BK-M
P023HT-XL
P023HT-L
P023HT-M



1 al 3



4 al 6

Damas

ITEM Descripción

- 1 Para damas color negro talla L
- 2 Para damas de color negro talla S
- 3 Para damas color gris talla M
- 4 Para damas color gris talla S

Código

- LP002BK-L
LP002BK-S
LP001HT-M
LP001HT-S



1-2



3-4

DELANTALES

ITEM Descripción

- 1 Con 4 bolsillos, negro 23"x12"
- 2 Con 3 bolsillos, negro 24"x12"
- 3 Largo con un bolsillo, negro 34" x 28"
- 4 Con un bolsillo, negro 31" x 26"
- 5 Con 2 bolsillo, azul 33"
- 6 Con 2 bolsillos, blanco 33"
- 7 De Vinyl para trabajo pesado color café
- 8 De pechera 36" x 45" color azul fabricado de vinyl
- 9 BLANCO DE VINILO REFORZADO C/ANILLOS PLASTICOS

Código

- WAP-BK
605WAFH-BK
607BA-BK
BA-PBK
BAP-BL
BA-PWH
APV-2641HD
614DVA-BL
40690-00



1



2



3



4



5-6



7



8



9

GUANTES

ITEM Descripción

- 1 Para horno de 15"
- 2 Para horno de 17"
- 3 Para freír
- 4 Para comida congelada
- 5 Para cortar de acero inoxidable
- 6 Resistente a cortaduras talla L color azul (unidad)
- 7 Resistente a cortaduras talla M color azul (unidad)
- 8 Resistente a cortaduras talla M color verde (unidad)
- 9 Resistente a cortaduras talla M color rojo (unidad)
- 10 De neopreno 17" (PAR)
- 11 De Neopreno 17"

Código

- TFR-15
TFR-17
6786RMT
FGI-OR
MGA515
SG10-BL-L
SG10-BL-M
SG10-GN-M
SG10-RD-M
1217EL
NEP-17



1-2



3



4



5



6-7



8



9



10



11

TOALLAS PARA COCINA

ITEM Descripción

- 1 Toalla de cocina 15x26"
- 2 Toalla de cocina 20X20"

Código

- 106110
RHB



LIMPIEZA



BIN PARA INGREDIENTES

ITEM Descripción

- 1 Bin para ingredientes 200 Tazas
- 2 Bin para ingredientes 400 tazas (360388 /3603-88BLA)
- 3 Combo de contenedor 25.60 galones blanco con tapa corrediza

Código
9G5800
FG360388WHT
FG9G7500



CAJAS Y TAPAS DE POLIETILENO

ITEM Descripción

- 1 Para Alimentos polietileno 16-5/8 gal 26"x18"x12"
- 2 Para Alimentos polietileno 5gal 18"x12"x9"
- 3 Para Alimentos polietileno 3-1/2 gal 18"x12"x6"
- 4 Tapa para FG350400WHT / FG350900WHT 18"x12"
- 5 Tapa para FG352800WHT 26"x18"
- 6 Para alimentos polietileno gris 20-1/2"x17-1/4"x7"
- 7 Tapa para caja gris PL-7G
- 8 Para alimentos polietileno blanco 15-1/4"x20-1/2"x7"
- 9 Para caja blanco BB-7FS
- 10 Para alimentos polietileno gris 15-1/4"x20-1/2"x7"
- 11 Tapa para caja gris BB-7G

Código
FG352800WHT
FG350400WHT
FG350900WHT
FG351000WHT
FG330200CLR
PL-7G
PL-57C
BB-7FS
BB-LIDSF
BB-7G
BB-LIDG



CAJAS Y TAPAS DE POLICARBONATO

ITEM Descripción

- 1 Para almacenar alimentos de18"x12"x9"
- 2 Para almacenar alimentos 12-1/2 gal 18"x26"x9"
- 3 Tapa para FG330400CLR 18"x12"
- 4 Tapa para FG330000CLR 18"x26"

Código
FG330400CLR
FG330000CLR
FG331000CLR
FG330200CLR

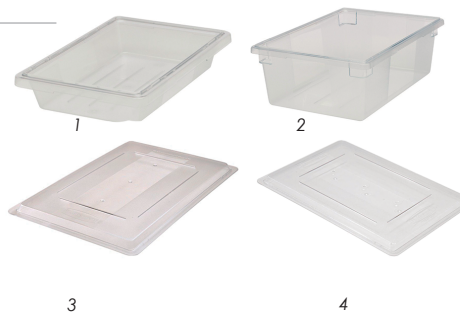

Bandeja de drenaje 26"x18"x5", 6" profundidad

FG330300CLR



RECIPIENTES Y TAPAS CUADRADAS

ITEM	Descripción	Código
1	De policarbonato Qt	6302TRA
2	De policarbonato 4 Qt	6304TRA
3	De policarbonato 6 Qt	6306TRA
4	De policarbonato 8 Qt	6308TRA
5	De policarbonato 12 Qt	6312TRA
6	De policarbonato 18 Qt	6318TRA
7	De policarbonato 22 Qt	6322TRA
8	Tapa para 6302TRA / 6304TRA / 6306TRA / 6308TRA	6509BLA
9	Tapa para 6312TRA / 6318TRA / 6322TRA	6523BLA



RECIPIENTES Y TAPAS REDONDOS

ITEM	Descripción	Código
1	Redondo de polipropileno semi transparente 2 Qt	5720-24
2	Redondo de polipropileno semi transparente 4 Qt	5721-24
3	Redondo de polipropileno semi transparente 6 Qt	5723-24
4	Redondo de polipropileno semi transparente 8 Qt	5724-24
5	Redondo de polipropileno semi transparente 18 Qt	5727-24 CLR
6	Redondo de polipropileno semi transparente 22 Qt	5728-24
7	Redondo de polipropileno blanco 2 Qt	FG572000WHT
8	Redondo de polipropileno blanco 4 Qt	FG572100WHT
9	Redondo de polipropileno blanco 6 Qt	5723-00
10	Redondo de polipropileno blanco 8 Qt	FG572400WHT
11	Redondo de polipropileno blanco 12 Qt	5726
12	Redondo de polipropileno blanco 18 Qt	5727
13	Redondo de polipropileno blanco 22 Qt	5728
14	Redondo de polipropileno blanco con agarradera metálica 22 Qt	5729
15	Tapa para 5720-24 / FG572000WHT / 5721-24 / FG572100WHT	5722-00
16	Tapa para 5723-24 / 5723-00 / 5724-24 / FG572400WHT	5725-00
17	Tapa para 5727-24 CLR / 5728-24 / 5728 / 5729	5730-00
18	Tapa para 5727-24 CLR / 5728-24 / 5728 / 5729	5730



RACK PARA VASOS / COPAS / PLATOS / CUBIERTOS

ITEM	Descripción	Código
1	Rack p/vasos con 20 compartimentos	20S638151
2	Rack p/vasos con 25 compartimentos	25S638
3	Rack p/vasos con 30 compartimentos	30S638151
4	Rack p/vasos con 36 compartimentos	36S638151
5	Rack p/platos 19-3/4" W x 19-3/4" L x 4" H	PR314151
6	Rack p/cubiertos 17 1/16" x 7 3/4" x 6 7/8"	C32P1
7	Rack p/cubiertos	FR258-G
8	Plataforma con ruedas 21.4" W x 21.4" L x 8" H	CDR2020151
9	Para almacenar cubiertos 4 depósitos	CUT-4PP



DISPENSADOR

Dispensador de jabón

S30TBK



CAMBIADORES DE BEBES

ITEM Descripción

- 1 Cambiador vertical para bebe, gris 23"Lx34.1"Wx4"H
- 2 Cambiador horizontal para bebe, gris 33.25"Lx21.5"Wx4"H

Código

FG781988LPLAT

FG781888LPLAT



1



2

EXPRIMIDORES

ITEM Descripción

- 1 Exprimidor de microfibra 16 Qt
- 2 Exprimidor para lampazo, capacidad de 35 Qt

Código

1791797

FG758088

FG9C7400



1

2

2

MECHAS

ITEM Descripción

- 1 100% algodón 16 Oz, blanca
- 2 65% algodón 35%PET 20 Oz con puntas cortadas, azul
- 3 100% algodón 16 Oz con puntas cortadas, blanca
- 4 100% algodón 24 Oz con puntas cortadas, blanca
- 5 De fibra sintética 24 Oz, azul

Código

E136

F517-00BL

F116

FGF11800WH

F132-00BL



1

2

3

4

5

PALOS

ITEM Descripción

- 1 Palo p/mechas de lampazo 60", amarillo
- 2 Lampazo con mango de aluminio y recubrimiento de vinil

Código

H116

FGH136



1

2

MOPAS

ITEM Descripción

- 1 Para polvo 24"x5", Blanco
- 2 65% algodón 35%PET de 36"Lx5"W, blanca

Código

K153-00WH

FGK15500



ARMAZON

ITEM Descripción

- 1 Palo p/mechas de lampazo 60", amarillo
- 2 Lampazo con mango de aluminio y recubrimiento de vinil

Código

FGM25300

FGM25500



PALO

Palo para mopas 60"L

FGM11600



CEPILLOS

ITEM Descripción

- 1 de mango corto
- 2 de mango largo
- 3 Para Inodoro
- 4 Base P/Cepillo De Inodoro
- 5 Para Inodoro

Código

FG9B2900

FG9B3200

6310-00

6311BLA

6320



1

2

3

4

5

ITEM Descripción

- 1 Cepillo para trabajo pesado para piso color gris punta roscada con mango de aluminio 57"
- 2 Cepillo para pisos con mango punta roscada de aluminio 57"

Código

9B15NEG

6355-00G

6337AZU

6355-00G



1

2

Escalera plegable de dos escalones gris

4209-03



Escalera de plástico de alta resistencia con ruedas siorta 350 lbs.

FG252300



Organizador para carrito de lujo negro de plástico reforzado

3154-88BLA



ESCURRIDORES DE PISO

ITEM	Descripción	Código
1	De piso con celdas dobles y cepillo	FG9C4400
2	De piso con celdas dobles	FG9C4100
3	Palo para escurridores	FG635500



ESCURRIDORES DE VENTANA

ITEM	Descripción	Código
1	Escurreidor de vidrio 10"	4007300
2	Escurreidor de vidrio 14"	4007400
3	Extensión para escurridor de ventana	4102001

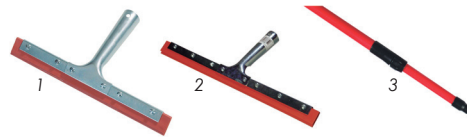

PALAS

ITEM	Descripción	Código
1	Plástica de mano	FG200500
2	Plástica completa	FG253100
3	Plastica con tapa	2532
4	Organizador de armarios/portautensilios	1993



CARROS PARA FOODSERVICES

ITEM	Descripción	Código
1	Deluxe de 3 repisas, de polietileno de alta densidad	FG9T6800
2	Con rueda 3" dia	3421NEG
3	De 3 repisas	FG342488



CARROS PARA LIMPIEZA

ITEM	Descripción	Código
1	De limpieza con bolsa	FG617388
2	38.25"Lx22"Wx44"H con bolsa	FG9T7700BLA
3	Con candado de seguridad en las puertas 55"Lx22"Wx56"H con bolsa	FG9T6400
4	Carro para limpieza 60"Lx22"Wx50"H con bolsa	FG619100
5	Bolsa Organizador de 9 bolsillos p/ carro de limpieza	9T90NEG
6	Bolsa de malla para carro de limpieza	9T91NEG



CARROS PARA LAVANDERIA

ITEM	Descripción	Código
1	24.1"L x 20.3"W x 34"H	1881749
2	35.7"L x 24.1"W x 34"H	1881750
3	35.7"L x 24.1"Wx34"H	1881781



CONTENEDORES Y TAPAS

ITEM	Descripción	Código
1	Contenedor Brute, gris plástico 10 gal	FG261000GRAY
2	Tapa p/contenedor, gris de 10 gal	FG260900GRAY
3	Contenedor Brute, gris de plástico 20 gal	FG262000GRAY
4	Tapa para contenedor, gris de 20 gal	2619
5	Contenedor blanco de 32 Gln	FG263200WHT
6	Contenedor Brute, amarillo plástico 32 gal	2632-00Y
7	Tapa p/contenedor amarillo 32 gal	2631
8	Contenedor Brute, gris plástico 32 gal	FG263200GRAY
9	Tapa plastica tipo Domo c/puerta abatible gris 32gl	2637-88
10	Tapa p/contenedor gris de 32 gal	2631GRI
11	Contenedor Brute, blanco de plástico 32 gal	FG263200WHT
12	Tapa p/contenedor brute blanco de 32 gal	FG263100WHT
13	Contenedor Brute, verde de plástico 32 gal	FG263200DGRN
14	Tapa P/Contenedor brute verde 32 gal	FG263100DGRN
15	Contenedor Brute, azul de plástico 32 gal	FG263288BLUE
16	Tapa p/contenedor brute azul de 32 gal	FG263100BLUE
17	Contenedor Brute, rojo de plástico 32 gal	FG263200RED
18	Tapa plastica tipo Domo c/puerta abatible rojo 32 gal	2637-R
19	Tapa p/contenedor brute rojo de 32 gal	FG263100RED
20	Contenedor Brute, gris plástico 44 gal	FG264300GRAY
21	Tapa forma d/embudo plastica p/ basureros de 32 gal	FG354300GRIS
22	Tapa p/contenedor estilo domo, gris 44 gal	FG264788GRAY
23	Tapa p/contenedor, gris de 44 gal	2645G
24	Contenedor Brute, amarillo plástico 44 gal	FG264300YEL
25	Tapa para alimentos amarillo 44 gal	FG264560WHT
26	Contenedor Brute, negro plástico 44 gal	FG264560YEL
27	Tapa plastica brute, negro 44 gal	FG264560BLA
28	Contenedor Brute, gris de plástico de 55 gal	FG265500GRAY
29	Tapa p/contenedor gris de 55 gal	2654GRI



CONTENEDORES ROLLOUT

Plataforma rodante negra

2640-BK



ITEM	Descripción	Código
1	Gris de polietileno de 50 gal	FG9W27GRI
2	Gris de polietileno de 65 gal	FG9W21GRI
3	Gris de polietileno de 95 gal	FG9W22GRI
4	Azul de Polietileno de 50 gal	FG9W2700
5	Azul de Polietileno de 65 gal	FG9W2173
6	Azul de Polietileno de 95 gal	FG9W2273



PLATAFORMAS

ITEM	Descripción	Código
1	Capacidad 1000 lb 61.5"l x 24.25"w x 44.62"h	FG449700BLA
2	Capacidad 2000 lb 36"l x 24"w	FG440600BLA
3	Capacidad 2000 lb 48"w x 24"l	FG443600BLA
4	Capacidad 2000 lb 56"l x 24.25"w x 41.25"h	FG448600BLA



VOLCADORES PARA BASURA

ITEM	Descripción	Código
1	Capacidad 850lb 72.52"l x 33.5"w x 43.75"h	FG131400BLA
2	Capacidad 2,100 lb 80.5"l x 43.5"w x 49.5"h	FG102600BLA



PAPELERAS

ITEM Descripción

- 1 Gris pequeño de 13 5/8 qt
- 2 Beige pequeño de 13 5/8 qt
- 3 Negro pequeño de 13 5/8 qt
- 4 Gris mediano de 28 1/8 qt tapas 3066 y 3066BEI
- 5 Beige mediano de 28 1/8 qt tapas 3066 y 3066BEI
- 6 Negro mediano de 28 1/8 qt tapas 3066 y 3066BEI
- 7 Con tapa abatible 22.9 lb
- 8 Beige grande de 41 1/4 qt tapas 3067NEG y 3067BEI
- 9 Negro grande de 41 1/4 qt tapas 3067NEG y 3067BEI

Código
FG295500GRAY
2955-BG
2955-BK
FG295600GRAY
2956BEI
2956NEG
307120BEI
2957BG
2957BK



BASUREROS

ITEM Descripción

- 1 Incluye tapa 15 gal
- 2 Cuadrado incluye tapa 23 gal
- 3 35 gal tapa 2664

Código
8160-BEI
7920-BEI
3958



BASURERO DE PEDAL

ITEM Descripción

- 1 De pedal de acero inoxidable 3.5 gal
- 2 Para depositar toallas sanitarias, gris 3 gal
- 3 De pedal, beige de plástico 8 gal
- 4 De pedal, beige de plástico 12 gal
- 5 De pedal, rojo de plástico 12 gal
- 6 De pedal, beige de plástico 14.5 gal
- 7 De pedal, beige de plástico 18 gal
- 8 De pedal, beige de plástico 23 gal
- 9 De pedal, plateado de plástico 30 gal

Código
MST35-SS
FG750244
614300
FG6144BEI
FG614400RED
FG617700BEIG
FG6145BEI
FG6146BEI
6147-00PLAT



BASURERO CON CENICERO

ITEM Descripción

- 1 Bronce/negro 3.5 gal
- 2 De acero inoxidable 3.5 gal

Código
1100-10BK
1100SSS



BASUREROS

ITEM Descripción

- 1 Con portabandejas beige 50 gal
- 2 Redondo de acero inoxidable 30 gal

Código
396300BEIG
FGR2030EPLBK



BASUREROS PARA RECICLAJE

ITEM Descripción

- 1 Cuadrado, azul 23 gal tapa FG269000BLUE
- 2 Para slim jim conranura papel de reciclaje color azul
- 3 Verde 23 gal tapa 2691
- 4 Plástica p/reciclaje de botellas verde 2691
- 5 Redondo reciclaje de plástico azul 21 gal tapa 3620-00BK
- 6 Tapa semicilíndrica oscilante p/basurero 3620-00BK
- 7 Contenedor con ruedas y tapa azul con logo reciclaje 50 gal 9W2773

Código
3569-AZU
FG269000BLUE
3569-VER
2691
352073BLUE
3620-00BK
9W2773



* Productos por pedidos Especiales

SEÑALES Y ROTULOS

ITEM	Descripción	Código
1	Advertencia - Cuidado piso mojado, 26"l x 11"wx25"h	6112-77
2	Advertencia -Cerrado, 26"l x 11"wx25"h	6112-78
3	Advertencia - Cuidado, 26"l x 11"wx25"h	6112AMA
4	Advertencia - Mojado 21"wx24"l	WFS-25
5	Accessible 6"h x 9"w	S69-13BL
6	Baño P/Damas 6"w x 9"h	S69B-5BK
7	Baño P/Caballeros 6"w x 9"h	S69B-6BK

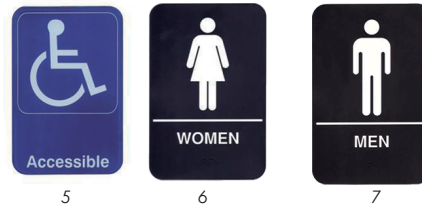

ALFOMBRAS

ITEM	Descripción	Código
1	Alfombra de hule blanca 14 "x 22-1 / 2"	703504WHT
2	Alfombra 3x5 negra antifatiga y antideslizante	2530-C5
3	Alfombra 3x3 roja	2523-R

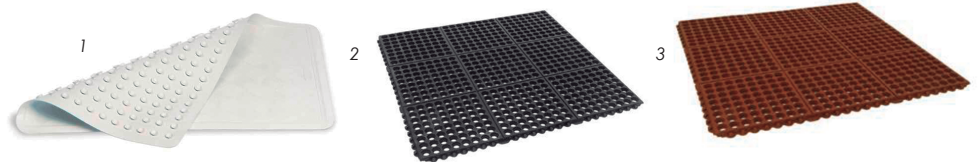

CEPILLO PARA LIMPIEZA

ITEM	Descripción	Código
1	Cepillo para limpieza máquina de café	31010
2	Cepillo para limpieza máquina de café	31301
3	Cepillo para limpieza máquina de café	31302
4	Cepillo para limpieza máquina de café	31305
5	Cepillo para limpieza máquina de café	31306
6	Cepillo para limpieza máquina de café	31330
7	Cepillo para limpieza máquina de café	31335





ALGUNAS DE NUESTRAS **MARCAS**



EXISTEN PRODUCTOS Y MARCAS DISPONIBLES **QUE NO SE PRESENTAN EN EL CATÁLOGO,**
PARA MAYOR INFORMACIÓN FAVOR CONTACTAR A NUESTROS ASESORES DE VENTAS.

The logo for economy mart features the word "economy" in red and "mart" in yellow, with a red swoosh above the "y" and "m".

economy mart

Rotonda El Güegüense 1/2c. al Norte · P.O. Box: 1449
Teléfono: +505 2268-3499 · Fax: +505 2268-2228

www.econo-mart.com

